



**KAMARAJ COLLEGE**  
SELF FINANCING COURSES  
(Reaccredited with "A+" Grade by NAAC)  
(Affiliated to Manonmaniam Sundaranar University, Tirunelveli.)  
THOOTHUKUDI – 628003.



**STUDY MATERIAL FOR B.SC. CHEMISTRY**  
**INORGANIC CHEMISTRY-I**  
**SEMESTER – I**



**Academic Year 2022-2023**

**Prepared by**

**CHEMISTRY DEPARTMENT**



**STUDY MATERIAL FOR B.SC CHEMISTRY  
INORGANIC CHEMISTRY - I  
SEMESTER - I, ACADEMIC YEAR 2022-23**

---



## Table of Content

UNIT	CONTENT	PAGE NO
I	ATOMIC STRUCTURE AND WAVE MECHANICS	3
II	PERIODIC TABLE AND PERIODIC PROPERTIES	23
III	CHEMICAL BONDING	34
IV	CHEMISTRY OF S AND P BLOCK ELEMENTS	55
V	PRINCIPLES OF QUALITATIVE AND QUANTITATIVE ANALYSIS	72



## Unit I

### Atomic Structure and Wave Mechanics

#### 1.1. Rutherford atom model

Ernest Rutherford was interested in knowing how the electrons are arranged within an atom. Rutherford designed an experiment for this. In this experiment, fast moving alpha ( $\alpha$ )-particles were made to fall on a thin gold foil.

- He selected a gold foil because he wanted as thin a layer as possible. This gold foil was about 1000 atoms thick.
- $\alpha$ -particles are doubly-charged helium ions. Since they have a mass of 4 u, the fast-moving  $\alpha$ -particles have a considerable amount of energy.
- It was expected that  $\alpha$ -particles would be deflected by the sub-atomic particles in the gold atoms. Since the  $\alpha$ -particles were much heavier than the protons, he did not expect to see large deflections.

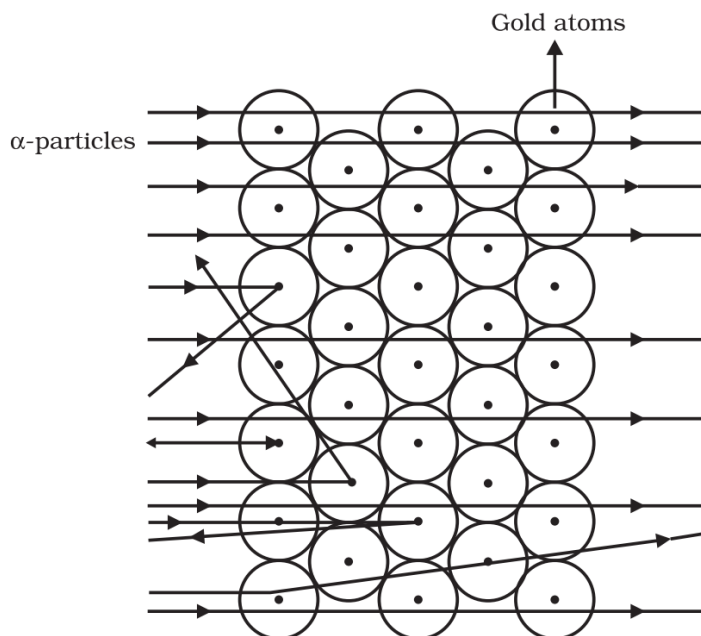

**Fig. 4.2:** Scattering of  $\alpha$ -particles by a gold foil



**STUDY MATERIAL FOR B.SC CHEMISTRY  
INORGANIC CHEMISTRY - I  
SEMESTER - I, ACADEMIC YEAR 2022-23**



But, the  $\alpha$ -particle scattering experiment gave totally unexpected results. The following observations were made:

- (i) Most of the fast moving  $\alpha$ -particles passed straight through the gold foil.
- (ii) Some of the  $\alpha$ -particles were deflected by the foil by small angles.
- (iii) Surprisingly one out of every 12000 particles appeared to rebound.

In the words of Rutherford, “This result was almost as incredible as if you fire a 15-inch shell at a piece of tissue paper and it comes back and hits you”. Let us think of an activity in an open field to understand the implications of this experiment. Let a child stand in front of a wall with his eyes closed. Let him throw stones at the wall from a distance. He will hear a sound when each stone strikes the wall. If he repeats this ten times, he will hear the sound ten times. But if a blind-folded child were to throw stones at a barbed-wire fence, most of the stones would not hit the fencing and no sound would be heard. This is because there are lots of gaps in the fence which allow the stone to pass through them.

Following a similar reasoning, Rutherford concluded from the  $\alpha$ -particle scattering experiment that–

- (i) Most of the space inside the atom is empty because most of the  $\alpha$ -particles passed through the gold foil without getting deflected.
- (ii) Very few particles were deflected from their path, indicating that the positive charge of the atom occupies very little space.
- (iii) A very small fraction of  $\alpha$ -particles were deflected by 180°, indicating that all the positive charge and mass of the gold atom were concentrated in a very small volume within the atom. From the data he also calculated that the radius of the nucleus is about 105 times less than the radius of the atom.

On the basis of his experiment, Rutherford put forward the nuclear model of an atom, which had the following features:

- (i) There is a positively charged centre in an atom called the nucleus. Nearly all the mass of an atom resides in the nucleus.
- (ii) The electrons revolve around the nucleus in circular paths.
- (iii) The size of the nucleus is very small as compared to the size of the atom.



**STUDY MATERIAL FOR B.SC CHEMISTRY  
INORGANIC CHEMISTRY - I  
SEMESTER - I, ACADEMIC YEAR 2022-23**



### **Drawbacks of Rutherford's model of the atom**

The revolution of the electron in a circular orbit is not expected to be stable. Any particle in a circular orbit would undergo acceleration. During acceleration, charged particles would radiate energy. Thus, the revolving electron would lose energy and finally fall into the nucleus. If this were so, the atom should be highly unstable and hence matter would not exist in the form that we know. We know that atoms are quite stable.

### **1.2. Planck's Quantum Theory**

Planck's quantum theory is a natural phenomenon of quantum mechanics. The theory was put forward by German physicist Max Planck. It explains the quantum nature of the energy of electromagnetic waves. Planck's quantum theory deals with phenomena such as the photoelectric effect and the nature of radiated emission which were not explained by the laws of classical mechanics.

The black body spectrum, which is the radiation emitted by a body that absorbs all the light that falls on it, shows significant divergence at higher frequencies. This divergence was at odds with hypothetical results predicted by the classical model of physics. Planck resolved this conundrum by theorizing that a particle in oscillation only absorbs radiation with a minimum amount of energy. Radiation with energy less than this minimum amount is not absorbed. The value of this minimum energy was discovered by Planck to be proportional to the frequency of oscillation of the oscillating particle. The relation between the energy required to excite the particle to a higher energy level and the frequency of the particle is given by the relation:

$$E = h\nu$$

Here,

$E$  is the minimum energy

$h$  is Planck's constant

$\nu$  is the frequency of the particle

This discovery proved significant in the later development of quantum mechanics. Planck's result showed that electromagnetic waves behave as both particles and waves when interacting with matter. This dual nature of electromagnetic radiation led to further investigations by de Broglie. He was successful in obtaining a formula for the wavelength of any particle with a mass and momentum. The relation between the wavelength of a body with its momentum is given by:



$$\lambda = \frac{h}{mv}$$

Here,

$h$  is Planck's constant

$m$  is the mass of the body

$v$  is the velocity of the body

### Electromagnetic Radiation

Electromagnetic radiation refers to the phenomenon of electromagnetic waves travelling through space. Electromagnetic waves do not need a medium to propagate. The radiation is sustained by the electric component and the magnetic component of the wave giving rise to each other through space. Both the components lie in mutually perpendicular planes. All electromagnetic waves have certain features associated with them. These can be summarised as below:

- Wavelength: Wavelength is the distance between two consecutive crests (elevation in the wave) or two consecutive troughs (depression in wave) of a wave.
- Frequency: Frequency can be defined as the number of waves occurring in a given interval of time.

Electromagnetic radiation can be classified based on its frequency and wavelength. Waves of higher frequency than the visible light come into the categories of x-rays, gamma rays and ultraviolet rays. While the waves of lower frequency than that of the visible light are infrared rays, radio waves and microwaves. Humans can only perceive electromagnetic waves that fall in a certain frequency range. The waves that fall in this range are called visible light.

### 1.3.Black body radiation

A black body is a body or object which absorbs all the radiation falling on it. An ideal black body absorbs and emits radiations of all frequencies. The emission of electromagnetic radiation from a black body depends on temperature. The frequency variation of emitted radiation from a black body can be described by Planck's law. This type of radiation is also known as Planck's radiation which is a type of thermal radiation. Varying with temperature, the higher the temperature of the body, the more is the emission of radiation of all wavelengths.



### Relation of black body radiation with Planck's law

Planck's radiation law describes the relation of temperature with radiated energy. With the increase in temperature, the radiation of every wavelength emitted from a black body also increases. The relation is given by:

$$B(\nu, T) = (2h\nu^3/c^2) \cdot (1/e^{h\nu/k_b T} - 1)$$

Where,

$\nu$  is for frequency,

$k_b$  is Boltzmann constant

$h$  is Planck's constant.

### Postulates of Planck's quantum theory

Planck's quantum theory states the following postulates:

1. The energy is not radiated or emitted continuously. It is emitted in small proportions in the form of energy packets called quanta.
2. Radiation when in the form of light, each particle is known as a photon. Photons are energy particles of small proportion in the case of light.
3. The energy of a photon or one quantum of energy is directly proportional to the frequency of the radiation.  $E = h\nu$  where  $h$  is Planck's constant and  $\nu$  is the frequency of radiation.
4. The total energy of radiation is represented as a whole number multiple of energy of a quantum as  $h\nu, 2h\nu, 3h\nu$  and so on.

#### 1.4. Photoelectric effect

When a beam of light of sufficiently high frequency is allowed to strike on a clean metal surface, electrons are ejected from the metal surface. This phenomenon is known as Photoelectric effect. The photon having sufficient energy when it strikes the metal surface then only the ejection of electron will take place. Otherwise electron will not be ejected. Some of the energy absorbed by an electron from photon is utilised to free the electron from the metal surface. Rest of the energy is converted to kinetic energy.

$$h\nu = W + K.E$$

where,  $h$  = Planck's constant



$\nu$  = Frequency

$w$  = Work function

KE = Kinetic energy

Einstein was able to explain the photoelectric effect.

### 1.5. The Bohr model

In the Rutherford model for the atom, the electrons reside outside the positively charged nucleus, and hence are accelerated by the Coulomb force. According to classical physics, the electrons must radiate electromagnetic waves. The energy loss would result in the electrons spiraling into the nucleus. At this time Niels Bohr was contemplating how Planck's quantum nature of radiation ideas could be applied to atomic spectra, and in particular the Rydberg formula for hydrogen. Bohr pictured the electron in hydrogen orbiting the central atomic nucleus. In 1915 he postulated a number of general assumptions:

a) Atoms have 'stationary states' of definite total energy. In these stationary states, the electrons do not radiate.

b) Emission or absorption of electromagnetic radiation occurs only in transitions from one stationary state to another. The frequency of the electromagnetic radiation is proportional to the energy difference of the two states, and the constant of proportionality is Planck's constant.

c) Classical physics describes the dynamical equilibrium of the atom in a stationary state but does not describe transitions between stationary states.

d) The mean value of the kinetic energy of the electron – nucleus system is quantized. For a circular orbit, Bohr pointed out that the quantization of kinetic energy was equivalent to the angular momentum of the system being an integer multiple of  $h$ . To derive the Rydberg formula for hydrogen from Bohr's assumptions, we will assume that the central nucleus is fixed. For an electron of mass  $m$  moving with speed  $v$  in a circular orbit of radius  $r$ , its angular momentum about the nucleus is

$$L = mvr$$

According to assumption d),  $L = mvr = n\hbar$ , where the integer  $n$  is called the principal quantum number. According to assumption c), we can apply Newton's second law to the motion of the electron. The Coulomb force provides the centripetal acceleration. Hence

$$k \frac{e^2}{r^2} = m \frac{v^2}{r}$$

The orbital velocity is then given by,



STUDY MATERIAL FOR B.SC CHEMISTRY  
INORGANIC CHEMISTRY - I  
SEMESTER - I, ACADEMIC YEAR 2022-23



$$v^2 = \frac{ke^2}{mr}$$

Using the quantization of angular momentum to eliminate  $v$ , we find that only certain values of the orbital radius are allowed:

$$r = \frac{n^2 \hbar^2}{kme^2} = n^2 a_0$$

where

$$\frac{\hbar^2}{kme^2} = a_0$$

is called the Bohr radius. Its numerical value is  $a_0 = 0.0529$  nm.

The kinetic and potential energies are

$$K = \frac{1}{2}mv^2 = \frac{1}{2} \frac{ke^2}{r} = \frac{1}{2} \frac{k^2me^4}{n^2\hbar^2}$$

$$U = -k \frac{e^2}{r} = -2K = -\frac{k^2me^4}{n^2\hbar^2}$$

$$E = K + U = -K = -\frac{1}{2} \frac{k^2me^4}{n^2\hbar^2}$$

Hence the energy of a photon associated with a transition between states of quantum numbers  $n_0$  and  $n$  is

$$hf = \frac{k^2me^4}{2\hbar^2} \left( \frac{1}{n_0^2} - \frac{1}{n^2} \right)$$

Since  $\lambda = fc$ , we obtain the Rydberg formula

$$\frac{1}{\lambda} = \frac{k^2me^4}{4\pi c\hbar^3} \left( \frac{1}{n_0^2} - \frac{1}{n^2} \right)$$

To take into account the finite mass of the nucleus,  $m$  must be replaced by the reduced mass, which for hydrogen is

$$\mu_H = \frac{mm_p}{m + m_p}$$



where  $m_p$  is the mass of the proton. Hence,

$$R_H = \frac{k^2 \mu_H e^4}{4\pi c \hbar^3}$$

### 1.6. Hydrogen Spectrum

Hydrogen atom contains only one electron and shows many lines in the spectrum. When hydrogen gas is subjected to electric discharge, hydrogen molecules absorb energy and split into atoms. The electrons in atoms absorb energy and will get excited and come back to their ground state and emit radiations of different frequencies. So we can show these series of lines observed in hydrogen spectrum in the table given below

**The Spectrum line for Atomic Hydrogen**

Series	$n_1$	$n_2$	Spectral Region
Lyman	1	2,3,4,....	Ultra Violet
Balmer	2	3,4,5,....	Visible
Paschen	3	4,5,6,....	Infrared (near)
Brackett	4	5,6,7,....	Infrared
Pfund	5	6,7,8,....	Infrared (far)

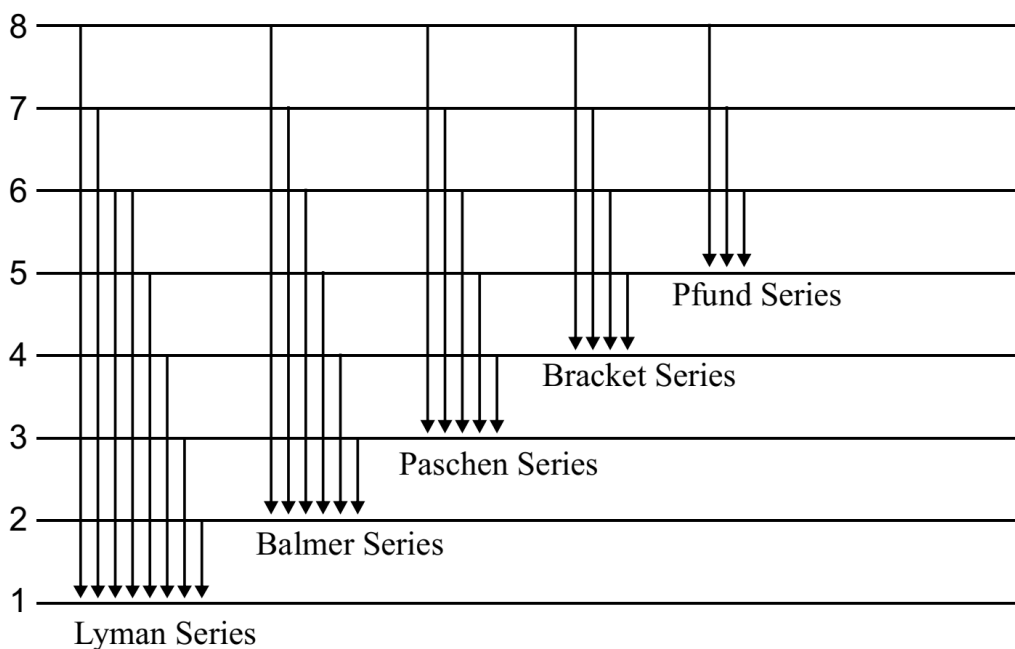



### Limitations of Bohr's Model of an atom

1. Bohr's Model of an atom could explain the spectrum of single electron species (H, He<sup>+</sup>, Li<sup>+2</sup> etc) but not the spectra of multielectron species.
2. Failed to explain Zeeman and Stark effects.
3. Cannot explain fine structure in the atomic spectra.
4. Cannot explain the formation of chemical bonds.
5. It failed to explain the dual nature of electrons.

### 1.7.Sommerfeld atomic model

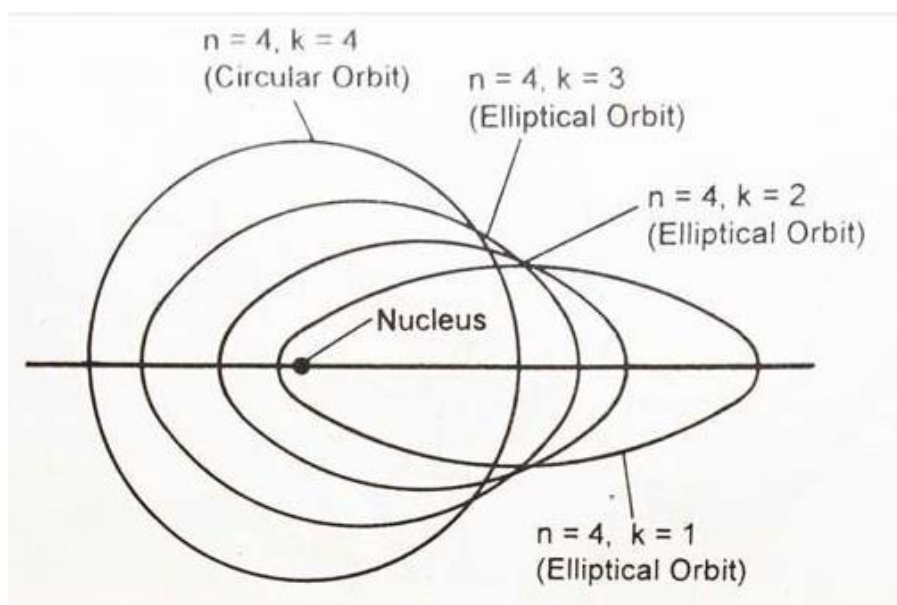

In 1919 Sommerfeld presented a modified and elaborated version of Bohr's atomic model. The fine structure of the hydrogen emission lines of the structure is of fine structure. To explain this, Sommerfeld suggested that it is not necessary that all the electrons of the same orbit have the same energy, the energies of some electrons of the same orbit may be different from the energies of the other electrons. In other words, the main energy levels are divided into sub-energy levels. It is not necessary that all the electrons of the same orbit rotate on the same circular path, rather some of them can move on the elliptical paths.

The nucleus of an atom is at one of the two foci of elliptical orbitals. The value of the angular momentum of an electron moving in a circular orbit is  $nh/2\pi$  where  $n$  is a whole number.



**STUDY MATERIAL FOR B.SC CHEMISTRY  
INORGANIC CHEMISTRY - I  
SEMESTER - I, ACADEMIC YEAR 2022-23**



$n$  is the main energy level of an electron or the number of orbits of the electron. The angular momentum of an electron moving in an elliptical orbit is  $kh/2\pi$  where  $k$  is a whole number.

The value of  $k$  can be 1, 2, 3, 4.... etc. The value of  $k$  represents the sub energy level of the electron.

The value of  $k$  depends on the value of  $n$ . For any one value of  $n$ , there are  $n$  values of  $k$ . These values of  $k$  are 1 2 3 .....  $n$ . If  $n = 1$  then  $k = 1$ .  $n = 2$  then  $k = 1, 2$ ,  $n = 3$  then  $k = 1, 2, 3$ .  $n = 4$  then  $k = 1, 2, 3, 4$  etc. When the values of  $k$  and  $n$  are equal, the orbitals of the electron will be circular i.e. the length of the long axis will be equal to the length of the short axis. Therefore

$$n/k = \text{length of the long axis/length of the short axis}$$

Sommerfeld's atomic model successfully explains the finer structure of the microstructure of the lines obtained in the emission spectrum of hydrogen. But this model, like Bohr's atomic model, fails to explain the emission spectrum of atoms or ions with more than one electron and the Zeeman Effect. Additionally, electrons have been considered as particles in Sommerfeld's atomic model. And their speed and place are completely fixed. After the discovery of electron's dual nature of electrons and the recognition of Heisenberg's principle of uncertainty, it becomes clear that Somerfield's atomic model is faulty.

### **1.8.De Broglie relation**

It is Bohr's postulate (d) that lead de Broglie to formulate his relation between momentum and wavelength. If the electron in the hydrogen atom is to be represented by a wave, then the circumference of the orbit must be an integer number of wavelengths,

$$n\lambda = 2\pi r$$

. The above equation can be written in terms of the electron momentum and radius of the orbit

$$L = rp$$

Bohr's quantization condition gives that

$$rp = n\hbar$$

Eliminating  $r$  from the above equations, we find,

$$p = \frac{n\hbar}{r} = \frac{nh}{2\pi r} = \frac{h}{\lambda}$$



which is the de Broglie relation

Quantum Mechanics is perhaps the greatest discovery in the field of Physics since the days of Isaac Newton. Heisenberg's Uncertainty principle is one of the most important tenets of this field. It is one of the most famous (and probably misunderstood) ideas in Physics. Let us try to understand more about the Heisenberg Uncertainty Formula.

### 1.9. Heisenberg Uncertainty Principle

The basic statement of the principle is that it is impossible to measure the position (x) and the momentum (p) of a particle with absolute accuracy or precision. The more accurately we know one of these values, the less accurately we know the other. Take for instance the scenario in which we try to view an electron. To view an electron we shine some photons (light) on it. These photons impart some energy to the electrons they are incident upon.

This leads to the electrons gaining some momentum and the calculations about the momentum are altered, alternatively, because the electrons move so fast, by the time the incident photons report back their positions the electrons would have already moved from there, thereby affecting the calculations about the position. This principle was fundamental to understanding the structure of an atom which was not understandable using the Newtonian or classical mechanics. It helped to overcome the deficiencies of the classical models of the atoms like the Bohr's model, Rutherford model etc. It basically stated that the product of the errors in the measurement of the momentum and the position is equal to a constant. Thus making it easier to measure the values. This led to a significant boost for the nascent field of quantum mechanics.

This principle also applies to the macroparticles like a tennis ball thrown, a car moving on a road etc. But as the dimensions of an object increase the principles of quantum mechanics do not yield significant results. Thus we can accurately know the position of a car as well as its speed simultaneously. This allows technologies like Google Maps etc. to function without any errors. So, Heisenberg's principle cannot be applied to macroparticles. As the results would turn out to be meaningless.

### Mathematical form of Heisenberg Uncertainty principle

Let the error in the measurement of the position and momentum be  $\Delta p$  and  $\Delta x$  respectively then :

$$\Delta p \times \Delta x \geq h/4\pi$$

where h is the Planck's constant with a value of  $6.626 \times 10^{-34}$  joule seconds



### 1.10. Schrodinger Equation

In 1925, Erwin Schrodinger introduced this partial differential equation for wave function definition as a reward to the Quantum mechanics branch. According to him, the wave function can be satisfied and solved. Here is a time-dependent equation of Schrodinger shown in the image below.

$$ih = \frac{\partial \psi}{\partial t}(\vec{r}, t) = \frac{-h^2}{2m} \Delta^2 + V(\vec{r}, t) \psi(\vec{r}, t)$$

In the above equations,

- m refers to the particle's mass.
- $\nabla$  is laplacian.
- h equals to  $h/2\pi$ , which is also known as the reduced Planck's constant.
- i is the imaginary unit.
- E is a constant matching energy level of a system

#### Properties of Wave Function

- There must be a single value for  $\Psi$ , and it must be continuous.
- It is easy to compute the energy using the Schrodinger equation.
- Wave function equation is used to establish probability distribution in 3D space.
- If there is a particle, then the probability of finding it becomes 1.
- Properties which can be measured for a particle should be known.

#### Normalization of Wave Function

In this scenario, the probability of finding a particle becomes 1 if it exists in the system. This depicts that the exact form of wave function  $\Psi$  is found.

#### Quantum Mechanics Postulates

1. It gets easier to decipher the force system wherein a particle in a conservative field resides with the help of a wave function.
2. Time independent Schrodinger's equation was derived using the time-dependent equation.

#### The 6 Postulates of Quantum Mechanics are:

1. Associated with any particle moving in a conservative field of force is a wave function which determines everything that can be known about the system.
2. With every physical observable q there is associated an operator Q, which when operating upon the wave function associated with a definite value of that observable will yield that value times the wavefunction.
3. Any operator Q associated with a physically measurable property q will be Hermitian.



**STUDY MATERIAL FOR B.SC CHEMISTRY  
INORGANIC CHEMISTRY - I  
SEMESTER - I, ACADEMIC YEAR 2022-23**



4. The set of eigenfunctions of operator  $Q$  will form a complete set of linearly independent functions.
5. Described by a given wave function for a system, the expected value of any property  $q$  can be found by performing the expectation value integral with respect to that wavefunction.
6. The time evolution of the wavefunction is given by the time dependent Schrodinger equation.

The total wavefunction must be antisymmetric with respect to the interchange of all coordinates of one fermion with those of another. Electronic spin must be included in this set of coordinates. The Pauli exclusion principle is a direct result of this antisymmetry principle.

### **The Physical Significance of Wave Function**

There is no physical meaning of wave function as it is not a quantity which can be observed. Instead, it is complex. It is expressed as  $\Psi(x, y, z, t) = a + ib$  and the complex conjugate of the wave function is expressed as  $\Psi^*(x, y, z, t) = a - ib$ . The product of these two indicates the probability density of finding a particle in space at a time. However,  $\Psi^2$  is the physical interpretation of wave function as it provides the probability information of locating a particle at allocation in a given time.

### **1.11. Quantum numbers**

$n$ ,  $l$ ,  $m_l$  quantum numbers are arrived to explain the wave function ( $\Psi$ ) of Schrodinger's wave equation. To explain the size of the orbit, energy of electron, shape of orbital, orientation and spin of electron four quantum numbers are predicted. They are

1. Principal quantum number ( $n$ )
2. Azimuthal quantum number ( $l$ )
3. Magnetic quantum number ( $m_l$ )
4. Spin quantum number ( $m_s$ )

#### **1) Principal Quantum number ( $n$ )**

This was proposed by Neils Bohr. It is denoted by the letter 'n' and given the values 1, 2, 3, 4. It represents orbits or shells around the nucleus and their size and energy. As the value of  $n$  increases the size and energy of orbit increases. In any orbit number of orbitals are given by  $n^2$  and number of electrons by  $2n^2$ .



## 2) Azimuthal Quantum Number ( $l$ )

This was proposed by Sommerfeld. It is denoted by letter ' $l$ '. It represents the sub-levels present in the main levels and can have the values 0 to  $(n-1)$ . The number of subshells in the main shell is equal to ' $n$ '.

$n$	$l$
1	0
2	0, 1
3	0, 1, 2

It describe the shape of the atomic orbitals

$l$	Orbital	Shape of the Orbit
0	s - Orbital	spherical
1	p - Orbital	dumbbell
2	d - Orbital	double dumbbell
3	f - Orbital	fourfold dumbbell

## 3. Magnetic Quantum number ( $m_l$ )

This was proposed by Lande. It is denoted by ' $m_l$ '. It describes the orbitals present in a given subshell and can have the values  $-l$  to  $+l$  through zero. These quantum numbers describes the orientation of orbitals in space and explain Zeeman and Stark effects

Sublevel	$l$ value	$m$ values	No. of Orbitals
s	0	0	1
p	1	-1, 0, +1	3
d	2	-2, -1, 0, +1, +2	5
f	3	-3, -2, -1, 0, +1, +2, +3	7

## 4. Spin Quantum number: ( $m_s$ )

It was proposed by Uhlenbeck and Goudsmit. It is denoted by  $m_s$ . This quantum number describes the spin of the electrons.  $m_s$  value of clockwise electron is  $+1/2$  and denoted by the sign  $\uparrow$  and that of anticlockwise electron is  $-1/2$  and denoted by the sign  $\downarrow$ .



### 1.12. Shapes Of s, p, and d Orbitals

An electron orbital is mathematical function used in describing the wave-like mechanism of either an electron or many pairs of electrons in an atom. This function is later used when in need of providing the probability of locating an atomic electron in a specified area in the nucleus of the atom.

#### Explanation

Every orbital is shown by a number and a letter. the energy level in the electron orbital is shown by a number, for instance, 1 shows the energy level nearest to the nucleus, number 2 shows the next energy level of energy, 3 the next one, and so on. Letters are there to refer to the shape of the orbital. These letters are s, p, d, f, g, h, I, j, and many more but here, we are only looking at letters p, s, and d and their corresponding shapes. You should know that it is impossible to draw an orbital because an electron is capable of taking up all space but we can draw the shape that it takes up most of the time, presumably 90% of the time.

#### 1. The s- Orbital

Around the atomic nucleus, the s orbitals are found to be spherically symmetric like a very hollow ball with a nucleus at the center. The orbitals grow bigger as the energy levels increase and the electrons get located far away from the nucleus. The size of the nucleus grows in the order of  $1s < 2s < 3s < 4s$  and so on as shown by the figure below. Now check the cross-section of the orbitals. Under a careful look, you will see that the 1s orbital contains little density of electrons nearer the nucleus but as you get further from the nucleus it builds up to the optimum. When it gets at the furthest point electron density starts to decrease rapidly.

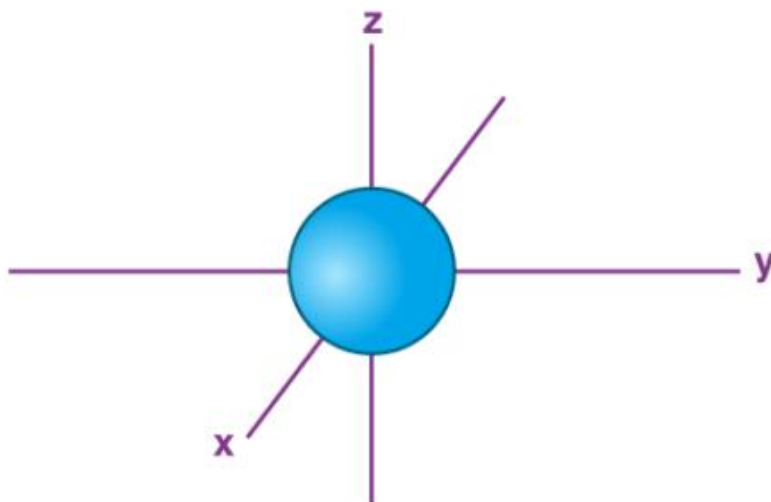



When you consider a 2s orbital you will notice that it has similarities with the 1s orbital. The only difference is that it contains a symmetrical sphere of electron density on the inside of the outer sphere. Much like putting a tennis ball inside another one. Between these two electrons, there is a surface that has no probability of locating an electron. It is called a nodal surface or simply a node. The 3s orbital is much larger than the first two and has three nodal surfaces.

### The p-orbital

You should know that not every electrons are found in s orbitals. The only orbitals to be located at the first energy level is the 1s orbital. However, the 2p orbitals are found in the second energy level together with the 2s orbitals. The difference between a 2s orbital and a 2p orbital is that a p orbital points in a certain direction while an s orbital points at no particular direction. See the diagram below.

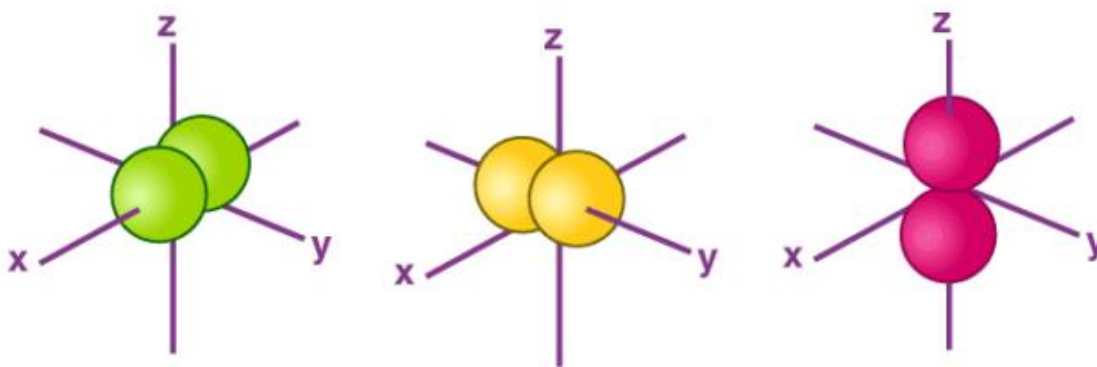

In any energy level, three equivalent p orbitals are found and points at right angles to each other. They are shown by symbols  $p_x$ ,  $p_y$  and  $p_z$ . This does not primarily mean that the symbols sticks because the orbitals are constantly changing directions as the atom moves. You should note that the p orbitals in the second energy level are named  $2p_x$ ,  $2p_y$  and  $2p_z$  and also  $3p_x$ ,  $3p_y$  and  $3p_z$  and so on. all levels have p orbitals in exception of the first level.

### The d-Orbitals

In the third energy level, five d orbitals are present. They have complicated names and shapes. The 3s and 3p ( $3p_x$ ,  $3p_y$   $3p_z$ ) are present too. A total of nine orbitals are found in the third energy level. The five 3d orbitals are named;  $3d_{xy}$ ,  $3d_{xz}$ ,  $3d_{yz}$ ,  $3d_{(x-y)^2}$  and  $3d_{z^2}$ .

The manes of the 3d orbitals are only understood when [put into groups. Group 1 has the  $3d_{xy}$ ,  $3d_{xz}$ , and  $3d_{yz}$  orbitals while the rest belongs to the second group. These names say that the orbitals lie in planes x-y, x-z, and y-z respectively. Every orbital contains four lobes and each lobe points in the middle of the two axes and not along the axes. Group 2 has the  $2d_{9x-y}^2$  and



$3d_{z^2}$ . The lobes of the two orbitals point along the axes. The  $3d_{(x-y)^2}$  orbitals are similar to group 1 in exception to that instead of the lobes pointing between the axes they point along the x and y axes. The  $3d_{z^2}$  orbitals are similar to a doughnut wearing p orbital.

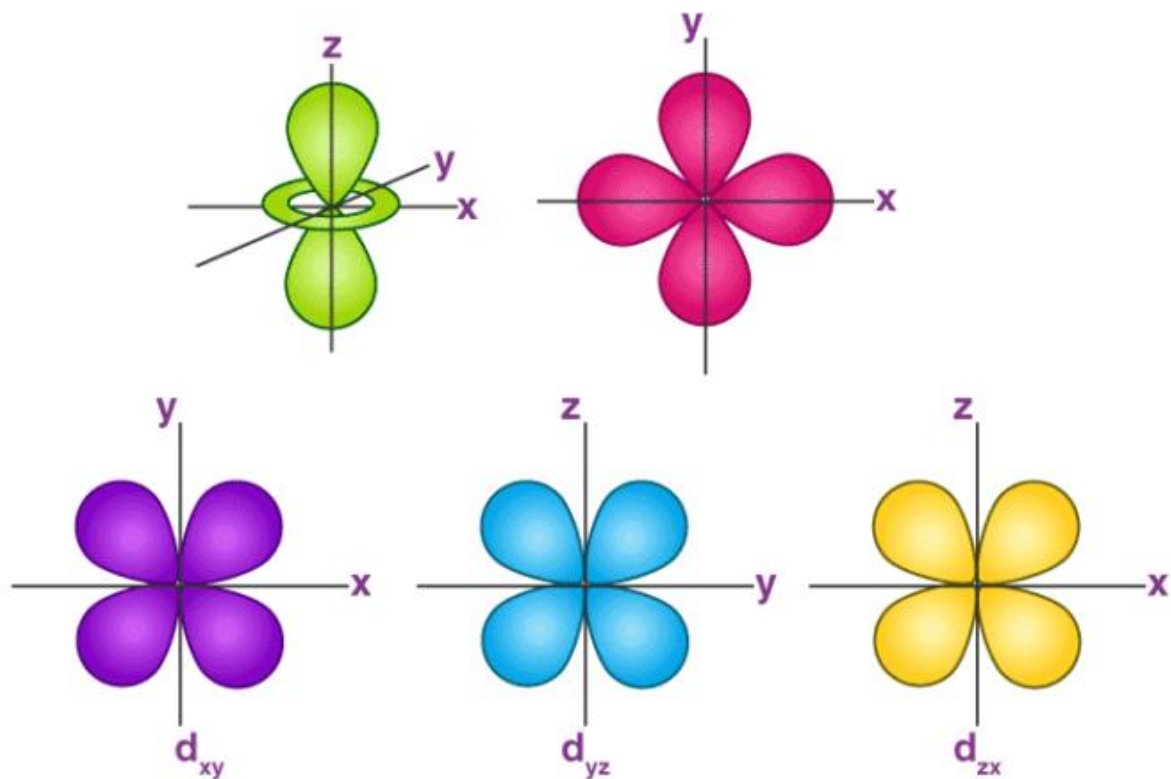

© Byjus.com

### 1.13. Pauli Exclusion Principle

The Pauli Exclusion principle is one of the important principles for the arrangement of electrons in an atom along with the Aufbau principle and Hund's rule. The Pauli exclusion principle states that- no two electrons can have the identical set of quantum numbers or quantum states simultaneously. Every electron should have a unique quantum number and quantum states. From the Pauli exclusion principle definition, we understood that No two electrons with up spin can be arranged together at the same time no two electrons with down spin can be arranged in a single quantum state. The Pauli exclusion principle in chemistry is as important as the Pauli exclusion principle in physics.

#### Pauli Exclusion Principle in Chemistry:

In chemistry, the principle is mainly used to explain or determine the electron shell structure of atoms and predict which atoms are likely to have free electrons at the end of configurations. How is the exclusion principle used in chemistry or where does it apply? So, if



**STUDY MATERIAL FOR B.SC CHEMISTRY  
INORGANIC CHEMISTRY - I  
SEMESTER - I, ACADEMIC YEAR 2022-23**



we have a look at the atoms whenever it gains a new electron or electrons it usually tries to reach their lowest energy state or it shifts to the outermost shell. Now, if the state has one electron then it can either be up spin or down spin. Therefore, now if we consider the Pauli exclusion principle if there are two electrons in a state, then each of the electrons must have either spin up or spin down but cannot have the same spin.

**Example:**

For better understanding let us have a look at an example. We can take the helium atom as a common example. The Helium atom has 2 electrons and they occupy the outermost shell with opposite spins. Here, we will see that the two electrons are in the 1s subshell where  $n = 1$ ,  $l = 0$ ,  $m_l = 0$  where  $n$ ,  $l$ , and  $m_l$  are the principal quantum number, orbital quantum number, and magnetic quantum number respectively. Now, both electrons will have different spins. One will be  $m_s = -1/2$  and the other will be  $+1/2$ . If we plot a diagram for the distribution, then the subshell of the helium atom will be represented with one up an electron and one down electron. Therefore, 1s subshell will have two electrons, which have opposite spins. Let us have a look at another example for the Pauli exclusion principle, if we take a hydrogen atom consisting of one electron, then it will have a 1s subshell with one up-spin electron ( $1s^1$ ). Moving forward, if we take up another atom such as Lithium it consists of 3 electrons, three electrons will be distributed in 2 subshells, first, two electrons will be distributed among 1s ( $1s^2$ ) subshell as an up-down spin pair and 2s ( $2s^2$ ) subshell will have a single electron with up spin. The distributions can be clearly understood if we draw the diagram as given below.

These are a few examples of how Pauli's exclusion principle is used. Pauli's exclusion principle plays an important role in atom physics as the arrangement of electrons is one of the important parts of the atomic structures. In advanced physics, the Pauli exclusion principle is one of the most basic observations of nature. When we try to calculate the probability of the electron in any given state, we need to write the wavefunctions. So, the particles of half-integer spin must have antisymmetric wavefunctions and particles with integer spin must have symmetric wave

**Aufbau principle**

Aufbau principle was discovered in the early 1920s and depicts that in the ground state of an atom, electrons fill atomic orbitals in order of their increase in energy. This means that the atomic orbitals with the lowest energy are filled by the electrons before occupying the upper atomic orbital. The order in which the atomic orbitals are filled by electrons is like, 1s, 2s, 2p, 3s, 3p, 4s, 3d, 4p, 5s, 4d, 5p, 6s, 4f, 5d, 6p, 7s, 5f, 6d, 7p, and more. An arrow is used to depict the electrons in an Aufbau Principle

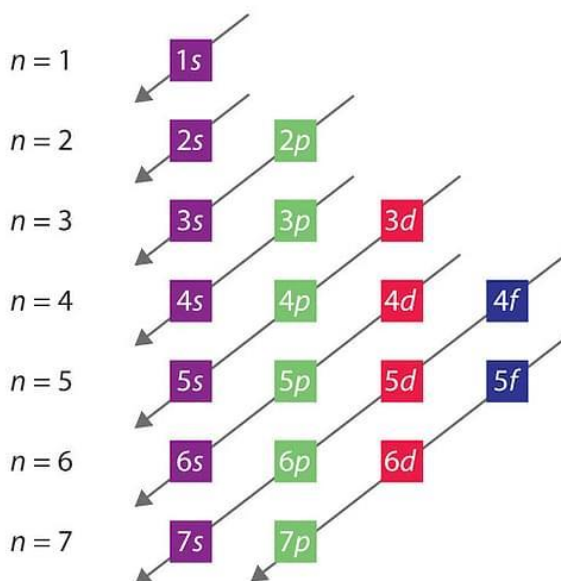

### Electronic Configuration according to Aufbau Principle

#### 2. Electronic Configuration of Sulphur

- The sulphur has 16 electrons since its atomic number is 16.
- According to the Aufbau principle, 2 electrons of sulphur are a part of the 1s subshell, 8 are a part of 2s and 2p and the remaining are scattered between the 3s and 3p.
- Hence sulphur's electron configuration can be written as,  $1s^2 2s^2 2p^6 3s^2 3p^4$  Electronic

#### 3. Configuration of Nitrogen.

- Nitrogen has an atomic number of 7 hence, its number of electrons is also equal to 7.
- The electrons are distributed between 1s, 2s and 2p orbitals.
- $1s^2 2s^2 2p^3$  can be written as Nitrogen's electronic configuration.

### 1.14. Hunds Rule of Maximum Multiplicity

Hunds Rule of Maximum Multiplicity rule states that for a given electron configuration, the term with maximum multiplicity falls lowest in energy. According to this rule electron pairing in p, d and f orbitals cannot occur until each orbital of a given subshell contains one electron each or is singly occupied.



## Explanation of Hund's Rule

**Electron pairing is not possible until all the available orbital's contain one electron each**

**Carbon atom**  
 $1s^2 2s^2 2p^2$

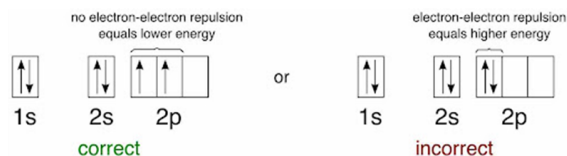

**Nitrogen atom**  
 $1s^2 2s^2 2p^3$

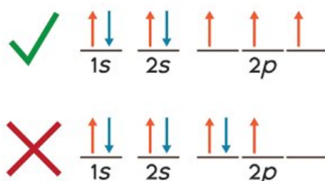

The electrons enter an empty orbital before pairing up. The electrons repel each other as they are negatively charged. The electrons do not share orbitals to reduce repulsion. When we consider the second rule, the spins of unpaired electrons in singly occupied orbitals are the same. The initial electrons spin in the sub-level decides what the spin of the other electrons would be. For instance, a carbon atom's electron configuration would be  $1s^2 2s^2 2p^2$ . The same orbital will be occupied by the two 2s electrons although different orbitals will be occupied by the two 2p electrons in reference to Hund's rule.



## Unit-II

### Periodic Table and Periodic Properties

#### **2.1.Modern periodic law**

The Modern Periodic Law states that the chemical and physical properties of elements are periodic functions of their atomic numbers. If elements are arranged in the order of their increasing atomic number, the elements with similar properties are repeated after certain regular intervals

#### **Long Form of Periodic Table**

The arrangement of elements in the long form of periodic table is a perfect matching of electronic configuration of the elements on one hand and physical and chemical properties of the elements on the other.

1. An atom loses electrons from or gains electrons in the outermost shell of an atom during a chemical reaction.
2. The sharing of an electron or electrons by an atom with other atom or atoms is largely through the outer most shell. Thus the electrons in the outermost shell of an atom largely determine the chemical properties of the elements.

The elements possessing identical outer electronic configuration should possess similar physical and chemical properties and therefore they should be placed together for an easy and systematic study.

#### **Features of Periodic Table**

There are 18 vertical columns called Groups. They are numbered from 1 to 18. Every group has a unique configuration. There are seven horizontal rows. These rows are called Periods. There are a total of 114 elements known. Of all the known elements, 90 are naturally occurring and others are made through nuclear transformations or are synthesized artificially.

First period consists of only two elements (very short period). Second and third period consists of only eight elements each (short periods). Fourth and fifth periods consist of 18 elements each (long periods). Sixth period consists of 32 elements (long period). Seventh period is yet incomplete and more and more elements are likely to be added as the scientific research advances.



**STUDY MATERIAL FOR B.SC CHEMISTRY**  
**INORGANIC CHEMISTRY - I**  
**SEMESTER - I, ACADEMIC YEAR 2022-23**



The periodic table is divided into four main blocks:

- s-block:** Groups 1 and 2 (Hydrogen, Alkali Metals, Alkaline Earth Metals).
- d-block:** Groups 3 to 10 (Transition Metals).
- p-block:** Groups 13 to 18 (Representative Elements, Halogens, Noble Gases).
- f-block:** Groups 3 and 4 (Inner Transition Elements: Lanthanoids and Actinoids).

Representative Elements ← s-block →		Transition Elements d-block										Representative Elements p-block						Noble gases 18	
1	H	2											13	14	15	16	17	He	
2	Li	Be											B	C	N	O	F	Ne	
3	Na	Mg	3	4	5	6	7	8	9	10	11	12	Al	Si	P	S	Cl	Ar	
4	K	Ca	Sc	Ti	V	Cr	Mn	Fe	Co	Ni	Cu	Zn	Ga	Ge	As	Se	Br	Kr	
5	Rb	Sr	Y	Zr	Nb	Mo	Tc	Ru	Rh	Pd	Ag	Cd	In	Sn	Sb	Te	I	Xe	
6	Cs	Ba		Hf	Ta	W	Re	Os	Ir	Pt	Au	Hg	Tl	Pb	Bi	Po	At	Rn	
7	Fr	Ra		Rf	Db	Sg	Bh	Hs	Mt										
			Inner Transition Elements f-block																
			La	Ce	Pr	Nd	Pm	Sm	Eu	Gd	Tb	Dy	Ho	Er	Tm	Yb	Lu		
			Ac	Th	Pa	U	Np	Pu	Am	Cm	Bk	Cf	Es	Fm	Md	No	Lr		

There are also nick names given to the groups or a cluster of groups on the basis of the similarity of their properties.

- Group 1 elements except hydrogen, are called Alkali Metals.
- Group 2 elements are called Alkaline Earth Metals.
- Group 3 to 12 elements are called Transition Metals.
- Group 16 elements are called Chalcogens.
- Group 17 elements are called Halogens.
- Group 18 elements are called Noble Gases.

Elements with atomic numbers 58 to 71 are called Lanthanoids or Inner Transition elements (First series). Elements from atomic numbers 90 to 103 are called Actinoids or Inner Transition elements (Second series). All elements except transition and inner transition elements are also collectively called Main Group Elements

## 2.2.Periodic Properties

1. Atomic radius
2. Ionization energy
3. Electron Affinity
4. Electronegativity

The repetition of properties of elements at regular intervals in the periodic table are called as periodic properties and the phenomenon is called periodicity.



**STUDY MATERIAL FOR B.SC CHEMISTRY  
INORGANIC CHEMISTRY - I  
SEMESTER - I, ACADEMIC YEAR 2022-23**



**(1) Atomic radius:**

The distance between the centre of the nucleus and the outermost shell of an atom is called its atomic radius.

**In a group:** Atomic radius in a group increases from top to bottom, because in every group, the differentiating electron enters into a new shell.

**In a period:** Atomic size decreases from left to right in a period, because the effective nuclear charge increases as the differentiating electron enters into the same shell.

**(2) Ionisation energy:**

The energy required to remove an electron from an isolated gaseous atom in its ground state is called ionisation enthalpy.

**In a group:** IE decreases in a group from top to bottom. As atomic size increases in a group from top to bottom, the screening effect increases. Hence nuclear attraction over valency electrons decreases and as a result IE decreases down the group.

**In a period:** IE increases in a period from left to right. As the atomic size decreases from left to right in a period, so the effective nuclear charge increases and nuclear attraction on valence electrons increases as a result I.E increases.

**(3) Electron Affinity:** The amount of energy released when an electron is added to the valence shell of neutral gaseous atom is called electron gain enthalpy.

**In a group:** Electron gain enthalpy decreases in a group. As we go down group atomic size increases. As a result the attraction between added electron and nucleus decreases.

**In a period:** Electron gain enthalpy increases in a period. As we go from left to right in a period atomic size decreases. As a result, the attraction between the added electron and nucleus increases.

**(4) Electro negativity:**

The tendency of an atom to attract the shared pair of electrons towards itself is called electronegativity.

**In a group:** Electronegativity decrease down the group. As we go down top to bottom in a group atomic size increases. As a result of which the tendency of attraction of nucleus on shared pair decreases.

**In a period:** Electronegativity increases across a period. As we go from left to right in a period, atomic size decreases. As a result of which the tendency of attraction of nucleus on shared pair increases.



**STUDY MATERIAL FOR B.SC CHEMISTRY  
INORGANIC CHEMISTRY - I  
SEMESTER - I, ACADEMIC YEAR 2022-23**



### 2.3. Ionization Energy:

**IE1:** The energy required to remove an electron from an isolated gaseous atom in its ground state is called as first Ionisation Enthalpy.

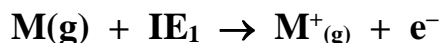

**IE2:** The energy required to remove an electron from uni positive gaseous ion is called as second Ionisation Enthalpy IE2.

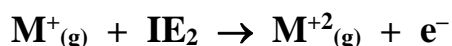

**IE2 > IE1:** The second Ionization enthalpy is greater than first ionization enthalpy. Because the number of protons is greater than number of electrons in the unipositive ion. Hence effective nuclear charge increases ie the nuclear attraction increases on the remaining electrons. Therefore more energy is required to remove an electron from uni positive ion.

$$\text{IE}_1 < \text{IE}_2 < \text{IE}_3$$

### Factors influencing the ionization enthalpy:

#### 1. Atomic radius:

As the atomic radius increases, the nuclear force of attraction over the valence electrons decreases so IE decreases.

$$IE \propto \frac{1}{\text{Atomic radius}}$$

#### 3. Nuclear charge:

As the nuclear charge increases the force of attraction on the valence electrons increases. Hence IE increases.

$$IE \propto \text{Nuclear charge}$$

#### 4. Screening effect or shielding effect:

The electrons present in inner orbitals decrease the nuclear attraction on the valence electrons. This is called screening or shielding effect. As the number of electrons in the inner shells increases, shielding effect increases. So IE decreases.



$$IE \propto \frac{1}{\text{Screening effect}}$$

**5. Extent of penetration of orbitals of valence electrons:**

- (a) Penetration Power of orbitals depends on the shape of the orbitals.
- (b) Penetration power of orbitals is in the order :  $s > p > d > f$

IE follows the order  $s > p > d > f$ .

**6. Half filled or completely filled sub shells:**

Atoms with half filled or completely filled sub shells are more stable. So IE values of these atoms are high.

**2.4. Electron Affinity**

Electron affinity is defined as the quantitative measurement of the energy change that results from adding a new electron to a neutral atom or molecule in the gaseous state. The more negative the electron affinity value, the higher an atom's affinity for electrons. The energy of an atom is stated when an atom loses or gains energy through chemical reactions that cause the loss or gain of electrons.

The reaction that releases energy is called an 'exothermic' reaction and the reaction in which energy is absorbed is called an 'endothermic' reaction. Talking about energies, energy from an endothermic reaction is positive. Hence, given a positive sign whereas energy from an exothermic reaction is negative. It is given a negative sign. The energy is released when an electron is being added to a neutral atom. Thus first electron affinities are always negative whereas second electron affinity ( electron to negative ion ) is positive. The electron affinity is further discussed below:

**First Electron Affinity:**



The energies are always concerned by the formation of positive ions. The first electron affinity is the energy released when 1 mole of gaseous atoms acquire an electron to form 1 mole of gaseous  $-1$  ions. Example: The first electron affinity of chlorine is  $-349 \text{ kJ mol}^{-1}$  The energy is needed to gain the electron when an electron is added to a metal element. However, metals are less likely to gain electrons as it is easier to lose their valence electrons and form cations. The reason behind losing their valence electrons is that metals' nuclei do not have a strong pull on their valence electrons. Therefore, metals are said to have lower electron affinities. The Trend of Lower Electron Affinities For Metals is described by Group 1 Metals:

Lithium (Li):  $-60 \text{ kJ mol}^{-1}$

Sodium (Na):  $-53 \text{ kJ mol}^{-1}$



**STUDY MATERIAL FOR B.SC CHEMISTRY  
INORGANIC CHEMISTRY - I  
SEMESTER - I, ACADEMIC YEAR 2022-23**



Potassium (K):  $-48 \text{ kJ mol}^{-1}$

Rubidium (Rb):  $-47 \text{ kJ mol}^{-1}$

Cesium (Cs):  $-46 \text{ kJ mol}^{-1}$

When nonmetals gain electrons, the energy change noted is negative because they give off energy. Non-metals have greater electron affinity because of their atomic structures. There are two reasons associated with why non-metals have greater electron affinity. Non-metals have more valence electrons than metals have which makes it easy to gain electrons to fulfill a stable octet. The valence electron shell is closer to the nucleus, this makes it harder to remove an electron. It is rather easy to attract an electron from another element.

**Example:** Non-metals like the elements in the Halogen series in Group 17 have higher electron affinity. The electron affinity trend is stated below:

Fluorine (F) :  $-328 \text{ kJ mol}^{-1}$

Chlorine (Cl) :  $-349 \text{ kJ mol}^{-1}$

Bromine (Br) :  $-324 \text{ kJ mol}^{-1}$

Iodine (I) :  $-295 \text{ kJ mol}^{-1}$

**Second Electron Affinity:**

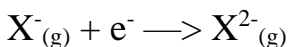

Second electron affinity is only met concerning the group 16 elements oxygen and sulfur which both form -2 ions. It is the energy required to add an electron to each ion in 1 mole of gaseous 1- ions to produce 1 mole of gaseous 2- ions.

**Factors Affecting Electron Affinity:**

Electron Affinity is affected by three main factors. These factors are generally related to the structure and configuration of the molecule in question. The three factors affecting the electron affinity of a molecule are Nuclear Charge, Atomic Size, and Electronic Configuration.

**1. Nuclear Charge:**

The greater the nuclear charge, the greater will be the attraction of the incoming electron. This will result in a larger value of electron affinity. To explain it in simpler terms, the nuclear charge can be understood as the pull that is exerted by the nucleus on the electrons. Therefore, the greater the pull of the nucleus, the greater the chance of electrons attaching to the atom.

**2. Atomic Size:**

The larger the size of an atom, the larger will be the distance between the nucleus and electron. This will result in a smaller force of attraction by electrons. Therefore, the value of electron affinity will be small. In general, too, the electronic affinity increases by going down the group and decreases from left to right across the periods.



### 3. Electronic Configuration:

Stable the configuration of an atom, its tendency will be less to accept the electron. Therefore, it will face a lower value of its electron affinity. Electron affinity is almost zero or low in elements having a stable electronic configuration. This is due to the small tendency to accept another electron. Electron affinities of inert gases are zero. This is due to their atoms having stable  $ns^2np^6$  configuration in their shell. Electron affinity of Beryllium, and calcium is practically zero. If the atom has fully or half-filled orbits, its electron affinity will be less.

#### Example:

Electron affinity of Be and N is almost 0 because they are having filled electrons in their valence shells. Filled orbits are all stable due to symmetry. Therefore, these elements will be having the least tendency to accept any electron. In general, the electron affinity follows the below trend: Halogens > Oxygen family > Carbon family > Nitrogen family > Metals of group 1 and 13 > Metals of group 2.

### 2.5. Electronegativity

Electronegativity is a chemical property that measures the tendency of an atom to attract electrons towards itself. Electronegativity is affected by the atomic number and the distance between the valence electrons and its nucleus. The higher the electronegativity is the more it attracts the electrons towards it.

#### Types of Electronegativity

##### 1. Non Polar Bond

When two atoms with equal electronegativity are bonded together in a molecule, a non polar bond is formed. These two atoms attracts bonding electrons equally towards themselves to form this sort of bond. It is more likely to happen in a molecule composed of same atoms. e.g.  $H_2$ ,  $N_2$  etc.



Here two equal electronegative atoms sharing electrons equally to form non polar covalent bond.

##### 2. Polar Bond

When two atoms with a slight difference in electronegativities are bonded together, a polar bond is formed. The atom with more electronegativities attracts electron more than the other atom towards itself to form this type of bond. e.g.  $HCl$ ,  $HF$  etc.





# STUDY MATERIAL FOR B.SC CHEMISTRY INORGANIC CHEMISTRY - I SEMESTER - I, ACADEMIC YEAR 2022-23



Here two atoms with a slight difference in electronegativity are sharing electrons unequally among themselves. As B is more electronegative than A, B attracts the bonding electrons towards itself to form polar bond.

### 3. Ionic bond

When two atoms with a greater difference in electronegativity bonded together, then ionic bond is formed. Here one electron is transferred from less electronegative atom to more electronegative atom to form this type of bond. e.g. NaCl.

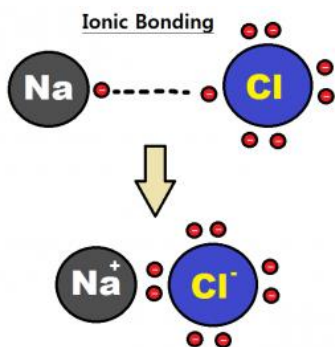

### Electronegativity in the periodic table

The Pauling scale is most commonly used to measure electronegativity. According to the scale Fluorine is the most electronegative element and its value is 4.0. Caesium and Francium are the least electronegative element and its value is 0.7.

Periodic table of electronegativity using the Pauling scale

→ Atomic radius decreases → Ionization energy increases → Electronegativity increases →

Group →	1	2	3	4	5	6	7	8	9	10	11	12	13	14	15	16	17	18
↓ Period																		
1	H 2.20																	He
2	Li 0.98	Be 1.57											B 2.04	C 2.55	N 3.04	O 3.44	F 3.98	Ne
3	Na 0.93	Mg 1.31											Al 1.61	Si 1.90	P 2.19	S 2.58	Cl 3.16	Ar
4	K 0.82	Ca 1.00	Sc 1.36	Ti 1.54	V 1.63	Cr 1.66	Mn 1.55	Fe 1.83	Co 1.88	Ni 1.91	Cu 1.90	Zn 1.66	Ga 1.81	Ge 2.01	As 2.18	Se 2.55	Br 2.96	Kr 3.00
5	Rb 0.82	Sr 0.95	Y 1.22	Zr 1.30	Nb 1.6	Mo 2.15	Tc 1.9	Ru 2.2	Rh 2.28	Pd 2.20	Ag 1.93	Cd 1.69	In 1.78	Sn 1.95	Sb 2.05	Te 2.1	I 2.66	Xe 2.60
6	Cs 0.79	Ba 0.89		Hf 1.3	Ta 1.6	W 2.36	Re 1.9	Os 2.2	Ir 2.20	Pt 2.28	Au 2.64	Hg 2.00	Tl 1.82	Pb 1.87	Bi 2.02	Po 2.0	At 2.2	Rn 2.2
7	Fr 0.7	Ra 0.9	**	Rf	Db	Sg	Bh	Hs	Mt	Ds	Rg	Cn	Nh	Fl	Uup	Lr	Uuq	Uub
* Lanthanoids	La 1.1	Ce 1.12	Pr 1.13	Nd 1.14	Pm 1.13	Sm 1.17	Eu 1.2	Gd 1.2	Tb 1.1	Dy 1.22	Ho 1.23	Er 1.24	Tm 1.25	Yb 1.1	Lu 1.27			
** Actinoids	Ac 1.1	Th 1.3	Pa 1.6	U 1.36	Np 1.36	Pu 1.28	Am 1.15	Cm 1.28	Bk 1.3	Cf 1.3	Es 1.3	Fm 1.3	Md 1.3	No 1.3	Lr 1.3			



**STUDY MATERIAL FOR B.SC CHEMISTRY  
INORGANIC CHEMISTRY - I  
SEMESTER - I, ACADEMIC YEAR 2022-23**



Here we can see that the electronegativity increases across the period and it decreases down the group. This can be explained with atomic number and the distance of valence electrons from nucleus.

### 1. Electronegativity increases across the period

Moving from left to right across a period, the number of protons and electrons increases while the number of energy shells stay same. Thus because of more attraction between increasing number of positive nucleus and negative electrons, the atomic radius decreases and the electronegativity (attraction of nucleus towards electrons) increases across the period.

### 2. Electronegativity decreases down the group

Moving down a group, the number of energy shells also increases with the increase of protons and electrons. So because of shielding effects of electrons in the increased inner shells, the attraction between electrons and nucleus (electronegativity) is reduced down the group.

### 3. Diagonal relationships in the periodic table

A diagonal relationship is said to exist between certain pairs of diagonally (not side by side) adjacent elements in second and third period in the periodic table.

main group

	1	2	13	14	15
period 2	Li	Be	B	C	N
period 3	Na	Mg	Al	Si	P

For example, lithium and magnesium, beryllium and aluminium, boron and silicon have similar properties. Boron and silicon both act as a semiconductors. This can be explained in terms of electronegativity. We already have seen that electronegativity increases across the period in periodic table. So, for example, the electronegativity of boron is more than beryllium.



Li	Be	B	
1.0	1.5	2.0	
	Mg	Al	Si
	1.2	1.5	1.8

Again it decreases down the period, so the electronegativity of aluminium is less than boron. Thus beryllium and aluminium both have less electronegativity than boron. This way the diagonal elements have similar (in this case same) electronegativities and similar properties than others.

## 2.6. Pauling's scale of electronegativity

Pauling's scale is based on an empirical relation between the energy of a bond and the electronegativity of bonded atoms. Consider a bond A-B between two dissimilar atoms A and B of a molecule AB. Let the bond energies of A-A, B-B and A-B bonds be represented as  $E_{A-A}$ ,  $E_{B-B}$  and  $E_{A-B}$  respectively. It may be seen that the bond dissociation energy of A-B is almost higher than the geometric mean of the bond dissociation energies of A-A and B-B bonds i.e.,  $E_{A-B} > (E_{A-A} \times E_{B-B})^{0.5}$

Their difference ( $\Delta$ ) is related to the difference in the electronegativities of A and B according to the following equation.

$$\Delta = E_{A-B} - \sqrt{E_{A-A} \times E_{B-B}}$$

$$\Delta = (X_A - X_B)^2$$

$$0.208\sqrt{\Delta} = X_A - X_B$$

Here,  $X_A$  and  $X_B$  are the electronegativities of A and B respectively. The factor 0.208 arises from the conversion of Kcals to electron volt. Considering arbitrarily the electronegativity of hydrogen to be 2.1, Pauling calculated electronegativities of other elements with the help of this equation.

### The disadvantage of Pauling scale:

The disadvantage of Pauling's scale is that bond energies are not known with any degree of accuracy for many solid elements.

## 2.7. Mulliken's electronegativity scale

Robert S. Mulliken proposed that the arithmetic mean of the first ionization energy ( $IE_1$ ) and the electron affinity (EA) should be a measure of the tendency of an atom to attract electrons. As this



**STUDY MATERIAL FOR B.SC CHEMISTRY  
INORGANIC CHEMISTRY - I  
SEMESTER - I, ACADEMIC YEAR 2022-23**



definition is not dependent on an arbitrary relative scale, it has also been termed *absolute electronegativity*. Using our definition of electron affinity, we can write Mulliken's original expression for electronegativity as follows: Mulliken's definition used the magnitude of the ionization energy and the electron affinity. By definition, the magnitude of a quantity is a positive number. Our definition of electron affinity produces negative values for the electron affinity for most elements, so vertical lines indicating absolute value are needed in Equation 1 to make sure that we are adding two positive numbers in the numerator.

$$\chi = \frac{IE_1 + EA}{2}$$



### Unit III

#### Chemical bonding

##### 3.1. Lattice Energy

Lattice energy is an estimate of the bond strength in ionic compounds. It is defined as the heat of formation for ions of opposite charge in the gas phase to combine into an ionic solid. As an example, the lattice energy of sodium chloride, NaCl, is the energy released when gaseous  $\text{Na}^+$  and  $\text{Cl}^-$  ions come together to form a lattice of alternating ions in the NaCl crystal.



The negative sign of the energy is indicative of an exothermic reaction. Alternatively, lattice energy can be thought of as the energy required to separate a mole of an ionic solid into the gaseous form of its ions (that is, the reverse of the reaction shown above).

##### 3.2. The Born-Landé' equation

The Born-Landé equation is a concept originally formulated in 1918 by the scientists Born and Lande and is used to calculate the lattice energy (measure of the strength of bonds) of a compound. This expression takes into account both the Born interactions as well as the Coulomb attractions. Due to its high simplicity and ease, the Born-Landé equation is commonly used by chemists when solving for lattice energy. This equation states that lattice energy can be derived from ionic lattice based on electrostatic potential and the potential energy due to repulsion. To solve for the Born-Landé equation, you must have a basic understanding of lattice energy:

- Lattice energy decreases as you go down a group (as atomic radii goes up, lattice energy goes down).
- Going across the periodic table, atomic radii decreases, therefore lattice energy increases.

The Born-Landé equation was derived from these two following equations. The first is the electrostatic potential energy:

$$\Delta U = - \frac{N_A M |Z^+| |Z^-| e^2}{4\pi\epsilon_0 r}$$



**STUDY MATERIAL FOR B.SC CHEMISTRY  
INORGANIC CHEMISTRY - I  
SEMESTER - I, ACADEMIC YEAR 2022-23**



- $N_A$  is Avogadro's constant ( $6.022 \times 10^{23}$ )
- $M$  is the Madelung Constant (a constant that varies for different structures)
- $e$  is the charge of an electron ( $1.6022 \times 10^{-19}$  C)
- $Z^+$  is the cation charge
- $Z^-$  is the anion charge
- $\epsilon_0$  is the permittivity of free space

The second equation is the repulsive interaction:

$$\Delta U = \frac{N_A B}{r^n}$$

- $B$  is the repulsion coefficient and
- $n$  is the Born Exponent (typically ranges between 5-12) that is used to measure how much a solid compresses

These equations combine to form:

$$\Delta U(0K) = \frac{N_A M |Z^+| |Z^-| e^2}{4\pi\epsilon_0 r} \left(1 - \frac{1}{n}\right)$$

- $r_0$  is the closest ion distance

### Calculate Lattice Energy

Lattice energy, based on the equation from above, is dependent on multiple factors. We see that the charge of ions is proportional to the increase in lattice energy. In addition, as ions come into closer contact, lattice energy also increases.

### 3.3. Factors affecting Lattice energy

- The two key factors which affect lattice energy,  $\Delta H_{latt}^\circ$ , are the **charge** and **radius** of the ions that make up the **crystalline lattice**

#### Ionic radius

- The lattice energy becomes **less exothermic** as the **ionic radius** of the ions **increases**
- This is because the charge on the ions is more **spread out** over the ion when the ions are **larger**



STUDY MATERIAL FOR B.SC CHEMISTRY  
INORGANIC CHEMISTRY - I  
SEMESTER - I, ACADEMIC YEAR 2022-23



- The ions are also **further apart** from each other in the lattice
  - The attraction between ions is between the centres of the ions involved, so the bigger the ions the bigger the distance between the centre of the ions
- Therefore, the **electrostatic forces of attraction** between the oppositely charged ions in the lattice are **weaker**
- For example, the lattice energy of caesium fluoride (CsF) is **less exothermic** than the lattice energy of potassium fluoride (KF)
  - Since both compounds contain a fluoride ( $F^-$ ) ion, the difference in lattice energy must be due to the caesium ( $Cs^+$ ) ion in CsF and potassium ( $K^+$ ) ion in KF
  - Potassium is a Group 1 and Period 4 element
  - Caesium is a Group 1 and Period 6 element
  - This means that the  $Cs^+$  ion is **larger** than the  $K^+$  ion
  - There are **weaker** electrostatic forces of attraction between the  $Cs^+$  and  $F^-$  ions compared to  $K^+$  and  $F^-$  ions
  - As a result, the **lattice energy** of CsF is **less exothermic** than that of KF

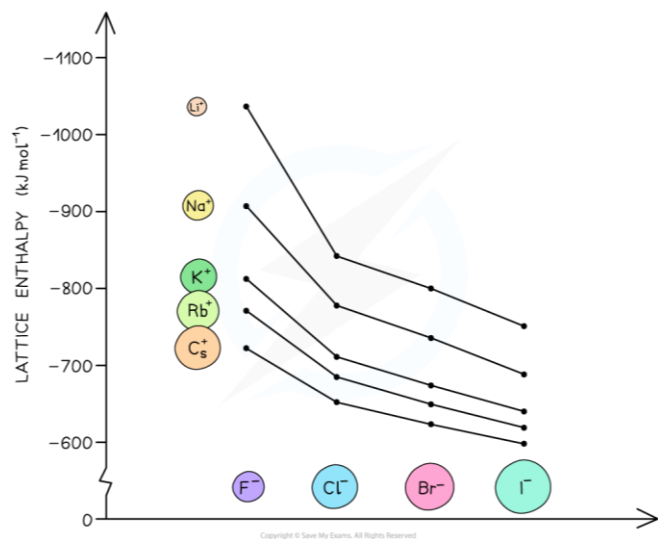

The lattice energies get less exothermic as the ionic radius of the ions increases

### Ionic charge

- The lattice energy gets **more exothermic** as the **ionic charge** of the ions **increases**
- The greater the ionic charge, the **higher the charge density**
- This results in **stronger electrostatic attraction** between the oppositely charged ions in the lattice



- As a result, the lattice energy is **more exothermic**
- For example, the lattice energy of calcium oxide (CaO) is **more exothermic** than the lattice energy of potassium chloride (KCl)
  - Calcium oxide is an ionic compound which consists of calcium (Ca<sup>2+</sup>) and oxide (O<sup>2-</sup>) ions
  - Potassium chloride is formed from potassium (K<sup>+</sup>) and chloride (Cl<sup>-</sup>) ions
  - The ions in calcium oxide have a **greater ionic charge** than the ions in potassium chloride
  - This means that the electrostatic forces of attraction are **stronger** between the Ca<sup>2+</sup> and O<sup>2-</sup> compared to the forces between K<sup>+</sup> and Cl<sup>-</sup>
  - Therefore, the lattice energy of calcium oxide is **more exothermic**, as more energy is released upon its formation from its gaseous ions
  - Ca<sup>2+</sup> and O<sup>2-</sup> are also smaller ions than K<sup>+</sup> and Cl<sup>-</sup>, so this also adds to the value for the lattice energy being more exothermic

### 3.4. Born Haber Cycle

Born Haber cycle is a cycle of enthalpy change of process that leads to the formation of a solid crystalline ionic compound from the elemental atoms in their standard state and of the enthalpy of formation of the solid compound such that the net enthalpy becomes zero.

#### Example 1:

#### Born Haber cycle of sodium chloride NaCl,

The heat of formation of sodium chloride ( $\Delta H_f^0$ ) from the sodium metal and chlorine gas can be experimentally measured.



The formation of ionic solid sodium chloride from solid sodium metal and gaseous chlorine is not a single step process but goes through several processes. Heat changes of all the processes except the lattice energy can be experimentally measured.

The processes or steps in the formation of sodium chloride are-

1. Solid sodium atom sublimates to gaseous atom by absorbing heat energy ( $\Delta H_{\text{sub}}$ ).

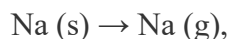

Sublimation energy  $\Delta H_{\text{sub}} = + 107\text{kJ/mol}$

2. Gaseous sodium atom absorbs the ionization energy to release one electron and forms gaseous sodium ion.

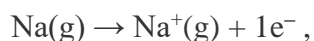



**STUDY MATERIAL FOR B.SC CHEMISTRY  
INORGANIC CHEMISTRY - I  
SEMESTER - I, ACADEMIC YEAR 2022-23**



Ionization energy  $\Delta H_{IE} = +502\text{kJ/mol}$

3. Diatomic gaseous chlorine breaks into two individual atoms by absorbing bond energy, such that each chlorine atom absorbs half of the bond energy of chlorine molecule.

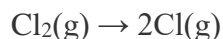

1/2 Bond dissociation energy of chlorine =  $1/2 \Delta H_{\text{diss}} = 1/2 \times 242 = +121\text{kJ/mol}$

4. Chlorine atom accepts an electron to form chloride ion and releases energy equivalent to electron affinity.

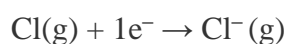

Electron affinity =  $\Delta H_{EA} = -355\text{kJ/mol}$

5. Gaseous sodium ion and gaseous chloride ion combine to form solid sodium chloride molecule and releases energy equivalent to lattice energy.

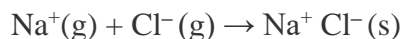

Lattice energy =  $\Delta H_{LE} = U = ?$

Summation of enthalpy of all the processes from step 1 to step 5) give the net enthalpy of formation of solid crystalline sodium chloride from sodium and chlorine in their standard conditions of solid and gas respectively. This should be equal to the experimentally measured enthalpy of formation of solid sodium chloride. The enthalpies are represented as a cycle in the figure.

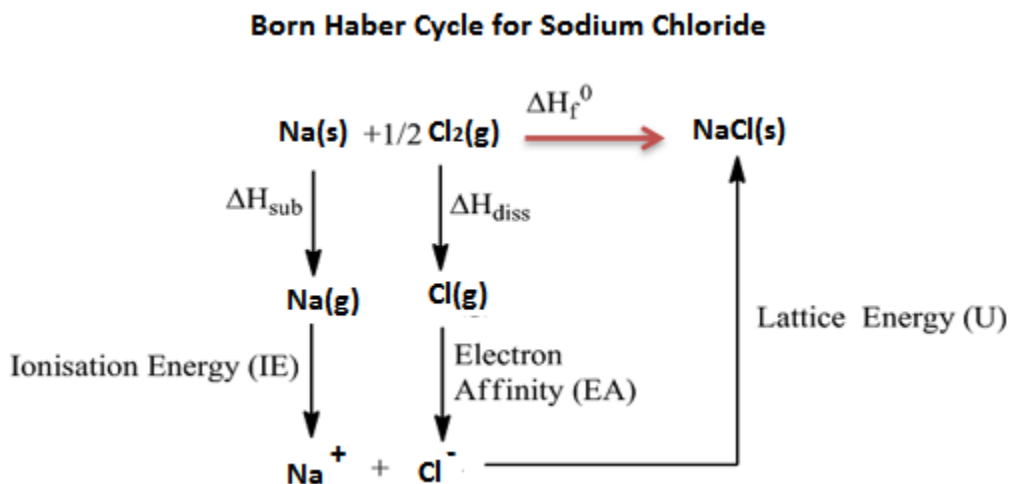



### 3.5. Fajans Rule

Fajans' rule predicts whether a chemical bond will be covalent or ionic. A few ionic bonds have partial covalent characteristics which were first discussed by Kazimierz Fajans in 1923. At that time with the help of X-ray crystallography, he was able to predict ionic or covalent bonding with the attributes like ionic and atomic radius.

## Fajan's Rules

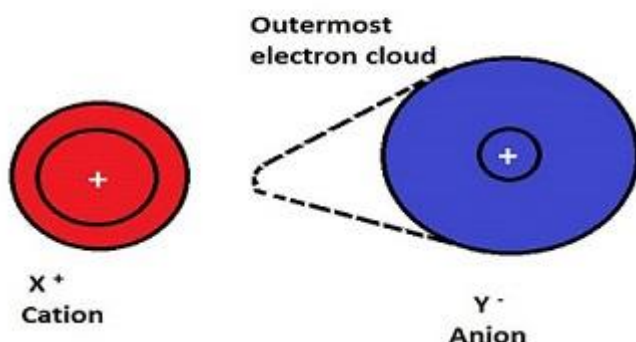

### Fajans' rule for Ionic and Covalent Compounds

To understand the Fajans' rule, let us first understand a few terms:

#### Polarising power

It is the extent to which a cation can polarise an anion. It is proportional to charge density. Charge density is the ratio of charge to volume. Polarising power  $\propto$  Charge density. More the charge density, greater is the polarising power for that cation.

#### Polarisability

It is the extent to which an ion can be polarised. It can also be called as the ease with which an ion can be polarised. Polarisation is the distortion of a spherically symmetric electron cloud to an unsymmetric cloud.



### Postulates of Fajans' Rule

The rule can be stated on the basis of 3 factors, which are:

1. Size of the ion: Smaller the size of cation, the larger the size of the anion, greater is the covalent character of the ionic bond.
2. The charge of Cation: Greater the charge of cation, greater is the covalent character of the ionic bond.
3. Electronic configuration: For cations with same charge and size, the one, with  $(n-1)d^n ns^0$  which is found in transition elements have greater covalent character than the cation with  $ns^2 np^6$  electronic configuration, which is commonly found in alkali or alkaline earth metals.

### Explanation of Fajans' Rule

#### Rule 1:

The first rule speaks about the polarising power of the cation. If the cation is smaller, then we can say that the volume of the ion is less. If the volume is less, we can conclude that the charge density of the ion would be high.

Since the charge density is high, the polarising power of the ion would be high. This makes the compound to be more covalent.

#### Rule 2:

The second rule speaks about the polarizability of the anion. Larger the anion, less is the effective nuclear charge that holds the valence electron of the ion in place. Since the last electron is loosely bound in large anions, it can easily be polarised by a cation, thereby making the compound more covalent.

#### Rule 3:

The third rule is a special case. Let us use an example to explain this point.

Example: If we want to find the more covalent compound among  $HgCl_2$  and Calcium Chloride we cannot use size as a factor to conclude. This is because both  $Hg^{2+}$  and  $Ca^{2+}$  are of almost equal size. To explain this, we employ the third rule. The electronic configuration of  $Hg^{2+}$  is  $6s^0 5d^{10}$ . This configuration is called pseudo-octet because d-orbital is fully filled, but the



**STUDY MATERIAL FOR B.SC CHEMISTRY  
INORGANIC CHEMISTRY - I  
SEMESTER - I, ACADEMIC YEAR 2022-23**



element does not have 8 electrons or an octet. We know that d orbitals are not good at shielding, so we can say that the anion ( $\text{Cl}^-$ ) would be more polarised because the d orbital is poor at shielding making  $\text{HgCl}_2$  more covalent than  $\text{CaCl}_2$  because  $\text{Ca}^{2+}$  ion has a noble gas configuration. Now to answer the question that we asked first, amongst the alkali chlorides, which one is the most covalent? Since the anion is the same, we have to compare the cations. According to Fajans' rules, smaller the cation, more is the covalency. Therefore,  $\text{LiCl}$  is the most covalent.

**Consider Aluminum Iodide ( $\text{AlI}_3$ )**

This is an ionic bond which was formed by transfer of electrons.

- The iodine being bigger has a lesser effective nuclear charge. Thus, the bonding electrons are attracted lesser towards the Iodine nucleus.
- On the contrary, the aluminium having three positive charges attracts the shared pair of electrons towards itself.
- This leads to insufficient charge separation for it to be ionic and so it results in the development of covalent character in  $\text{AlI}_3$ .

**Consider Aluminium Fluoride ( $\text{AlF}_3$ )**

This is an ionic bond which was also formed by transfer of electron. But here the fluorine being smaller attracts the shared pair of an electron more towards itself and so there is sufficient charge separation to make it ionic.

**Examples on Fajans' rule**

Illustration 1: Which compound should theoretically the most ionic and the most covalent amongst the metal halides?

Solution:

The smallest metal ion and the largest anion should technically be the most covalent

Therefore,  $\text{LiI}$  is the most covalent.

The largest cation and the smallest anion should be the most ionic. Therefore,  $\text{CsF}$  should be the most ionic.

Illustration 2: Arrange the following according to the increasing order of covalency:

- $\text{NaF}$ ,  $\text{NaCl}$ ,  $\text{NaBr}$ ,  $\text{NaI}$
- $\text{LiF}$ ,  $\text{NaF}$ ,  $\text{KF}$ ,  $\text{RbF}$ ,  $\text{CsF}$

**Solution:**

1. Since the cation is the same, compare the anions. Amongst the anions, larger the size more would be the covalency. Therefore the order is:  $\text{NaF} < \text{NaCl} < \text{NaBr} < \text{NaI}$

2. Here the anion is the same, so we compare with cations. Smaller the cation more is the covalency. Therefore, the order is:  $\text{CsF} < \text{RbF} < \text{KF} < \text{NaF} < \text{LiF}$



### 3.6. Valence Bond Theory

This theory focuses on the concepts of electronic configuration, atomic orbitals (and their overlapping) and the hybridization of these atomic orbitals. Chemical bonds are formed from the overlapping of atomic orbitals wherein the electrons are localized in the corresponding bond region. The valence bond theory also goes on to explain the electronic structure of the molecules formed by this overlapping of atomic orbitals. It also emphasizes that the nucleus of one atom in a molecule is attracted to the electrons of the other atoms.

#### Postulates of VB theory

The important postulates of the valence bond theory are listed below.

1. Covalent bonds are formed when two valence orbitals (half-filled) belonging to two different atoms overlap on each other. The electron density in the area between the two bonding atoms increases as a result of this overlapping, thereby increasing the stability of the resulting molecule.
2. The presence of many unpaired electrons in the valence shell of an atom enables it to form multiple bonds with other atoms. The paired electrons present in the valence shell do not take part in the formation of chemical bonds as per the valence bond theory.
3. Covalent chemical bonds are directional and are also parallel to the region corresponding to the atomic orbitals that are overlapping.
4. Sigma bonds and pi bonds differ in the pattern that the atomic orbitals overlap in, i.e. pi bonds are formed from sidewise overlapping whereas the overlapping along the axis containing the nuclei of the two atoms leads to the formation of sigma bonds.

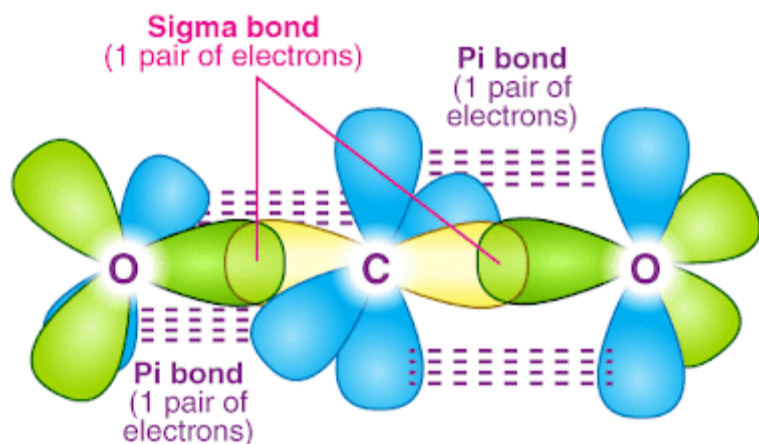



**STUDY MATERIAL FOR B.SC CHEMISTRY**  
**INORGANIC CHEMISTRY - I**  
**SEMESTER - I, ACADEMIC YEAR 2022-23**



It can be noted that sigma bonds involve the head-to-head overlapping of atomic orbitals whereas pi bonds involve parallel overlapping.

### Number of Orbitals and Types of Hybridization

According to VBT theory the metal atom or ion under the influence of ligands can use its (n-1)d, ns, np, or ns, np, nd orbitals for hybridization to yield a set of equivalent orbitals of definite geometry such as octahedral, tetrahedral, square planar and so on. These hybrid orbitals are allowed to overlap with ligand orbitals that can donate electron pairs for bonding.

Coordination Number	Type of Hybridisation	Distribution of Hybrid Orbitals in Space
4	$sp^3$	Tetrahedral
4	$dsp^2$	Square planar
5	$sp^3d$	Trigonal bipyramidal
6	$sp^3d^2$	Octahedral
6	$d^2sp^3$	Octahedral

### Applications of Valence Bond Theory

- The maximum overlap condition which is described by the valence bond theory can explain the formation of covalent bonds in several molecules.
- This is one of its most important applications. For example, the difference in the length and strength of the chemical bonds in  $H_2$  and  $F_2$  molecules can be explained by the difference in the overlapping orbitals in these molecules.
- The covalent bond in an HF molecule is formed from the overlap of the 1s orbital of the hydrogen atom and a 2p orbital belonging to the fluorine atom, which is explained by the valence bond theory.



### Limitations of Valence Bond Theory

The shortcomings of the valence bond theory include

- Failure to explain the tetravalency exhibited by carbon.
- No insight offered on the energies of the electrons.
- The theory assumes that electrons are localized in specific areas.
- It does not give a quantitative interpretation of the thermodynamic or kinetic stabilities of coordination compounds.
- No distinction between weak and strong ligands.
- No explanation for the colour exhibited by coordination compounds.

### 3.7. Valence-Shell Electron-Pair Repulsion (VSEPR) Theory

The Valence Shell Electron Repulsion (VSEPR) model can predict the structure of most molecules and polyatomic ions with a nonmetal central atom; it can also predict the structure of certain metal-centered molecules and polyatomic ions. VSEPR is based on Lewis electron dot structures, which can predict the geometry of each atom in a molecule when used combined. Lewis structures alone can only predict connectivity, but VSEPR and Lewis structures together can predict the geometry of each atom in a molecule.

*VSEPR theory is based on the premise that pairs of electrons (in bonds and lone pairs) repel each other. “Groups” refer to electron pairs (both in bonds and lone pairs). Because electrons oppose each other electrostatically, the most stable electron group configuration (i.e., the one with the lowest energy) reduces repulsion.*

The molecular structure with the lowest energy is created by arranging groups around the centre atom. To put it another way, the repulsion between groups around an atom promotes a geometry in which the groups are as far away as feasible. VSEPR is a simple model that successfully predicts the three-dimensional structures of a vast number of compounds, despite the fact that it does not account for the intricacies of orbital interactions that determine molecule shapes.

### Valence-Shell Electron-Pair Repulsion (VSEPR) Theory

Ronald Nyholm and Ronald Gillespie are the key creators of the VSEPR theory. To honour these chemists, this hypothesis is sometimes known as the Gillespie-Nyholm theory. The VSEPR theory states that the repulsion between two electrons is caused by the Pauli exclusion principle, which is more important than electrostatic repulsion in determining molecule shape.



**STUDY MATERIAL FOR B.SC CHEMISTRY  
INORGANIC CHEMISTRY - I  
SEMESTER - I, ACADEMIC YEAR 2022-23**



*The Valence Shell Electron Pair Repulsion Theory, abbreviated as VSEPR theory, is founded on the idea that all atoms have a repulsion between pairs of valence electrons, and that atoms will always seek to arrange themselves in a way that minimises this electron pair repulsion. The geometry of the final molecule is determined by the arrangement of the atoms.*

The table below shows the various geometries that molecules can adopt in accordance with the VSEPR theory.

Number of Electron Dense Area	Electron Pair Geometry	No Lone Pair	1 Lone Pair	2 Lone Pair	3 Lone Pair	4 Lone Pair
2	Linear	Linear	–	–	–	–
3	Trigonal Planar	Trigonal Planar	Bent	–	–	–
4	Tetrahedral	Tetrahedral	Trigonal Pyramidal	Bent	–	–
5	Trigonal Bipyramidal	Trigonal Bipyramidal	Sawhorse	T-shaped	Linear	–
6	Octahedral	Octahedral	Square Pyramidal	Square Planar	T-Shaped	Linear

### Postulates of VSEPR Theory

1. In polyatomic molecules (molecules composed of three or more atoms), one of the constituent atoms is designated as the central atom, to which all other atoms in the molecule are attached.
2. The total amount of valence shell electron pairs determines the molecule's structure.
3. Electron pairs have a tendency to organise themselves in such a way that their electron-electron repulsion is minimised while their distance is increased.



**STUDY MATERIAL FOR B.SC CHEMISTRY  
INORGANIC CHEMISTRY - I  
SEMESTER - I, ACADEMIC YEAR 2022-23**



4. The valence shell can be visualised as a sphere with electron pairs clustered on its surface to reduce the distance between them.
5. If the core atom of the molecule is surrounded by electron bond pairs, an asymmetrically structured molecule can be expected.
6. If the centre atom is surrounded by both lone pairs and bond pairs of electrons, the molecule will be deformed.
7. The VSEPR theory can be applied to any molecule's resonance structure.
8. The repulsion is largest between two lone pairs and smallest between two bond pairs.
9. If electron pairs around the core atom get too close, they will reject each other. As a result, the energy of the molecules increases.
10. If the electron pairs are separated by a large distance, the repulsions between them are reduced, and the energy of the molecule is reduced.

### **Limitations of VSEPR Theory**

1. This theory fails to account for isoelectronic species (i.e. elements having the same number of electrons). Despite having the same number of electrons, the shapes of the species can differ.
2. The VSEPR hypothesis does not throw any light on transition metal complexes. This theory cannot accurately describe the structure of several such molecules. This is because the VSEPR hypothesis does not account for the related sizes of the substituent groups and the inactive lone pairs.
3. Another drawback of VSEPR theory is that it predicts that halides of group 2 elements will have a linear structure whereas in fact they have a bent structure.

### **Predicting the Shapes of Molecules**

1. As the centre atom, the least electronegative atom must be chosen (since this atom has the highest ability to share its electrons with the other atoms belonging to the molecule).
2. The total number of electrons in the core atom's outermost shell must be counted.
3. It is necessary to count the total number of electrons belonging to other atoms and utilise them in bonding with the centre atom.
4. These two numbers must be summed to yield the valence shell electron pair number, abbreviated as the VSEP number.



## Shapes

### Linear Shape

There are two sites in the valence shell of the central atom in this sort of molecule. They should be organised in such a way that repulsion is reduced (pointing in the opposite direction).  $\text{BeF}_2$  is an example.



*Linear Shape*

### Trigonal Planar Shape

Three molecules are connected to a central atom in this sort of molecule. They are placed in such a way that electron repulsion between them is reduced (toward the corners of an equilateral triangle).  $\text{BF}_3$  is an example.

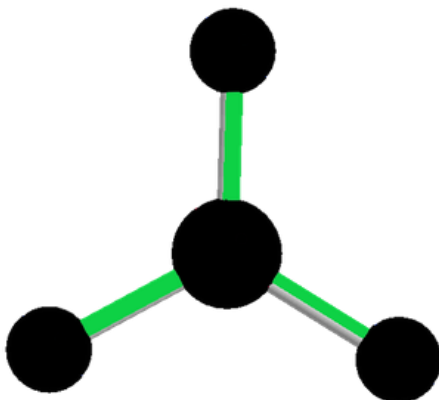

*Trigonal Planar Shape*

### Tetrahedral Shape

Atoms in two-dimensional molecules lie in the same plane, and if we apply these criteria to methane, we get a square planar geometry with a bond angle of 90 degrees between H-C-H. When all of these prerequisites for a three-dimensional molecule are met, we get a tetrahedral molecule in  $\text{CH}_4$ .



*Tetrahedral Shape*

### **Trigonal Bipyramid Shape**

Let's look at  $\text{PF}_5$  as an example. Repulsion can be reduced by distributing electrons evenly towards the corners of a trigonal pyramid. Three places along the molecule's equator are found in trigonal bipyramids. The two places are parallel to each other on an axis perpendicular to the equatorial plane.

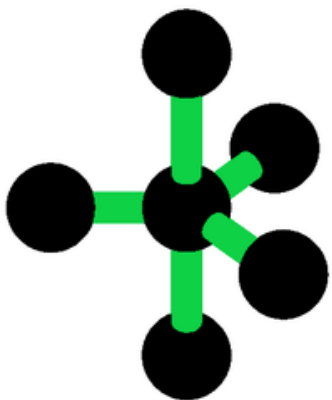

*Trigonal Bipyramidal Shape*

### **3.8. Molecular Orbital Theory**

Molecular Orbital Theory (MOT) was proposed by F.Hund and R.S. Mulliken in the early twentieth century to describe the electronic structure of molecules. The theory is based on the mathematical expression to calculate the movement and sharing of electrons. According to this theory, the bonding between atoms is described as a combination of an atomic orbital. When the force of attraction between an electron and two nuclei exceeds the electrostatic repulsion between the two nuclei, chemical bonding occurs.



**STUDY MATERIAL FOR B.SC CHEMISTRY  
INORGANIC CHEMISTRY - I  
SEMESTER - I, ACADEMIC YEAR 2022-23**



As per Molecular Orbital Theory, the orbitals are filled according to the following rules/principles:

- **Aufbau's principle:** Molecular orbitals are filled in the increasing order of **energy levels**
- **Pauli's exclusion principle:** In an atom or a molecule, no two electrons can have the same set of four **quantum numbers**.
- **Hund's rule of maximum multiplicity:** Pairing of electrons doesn't take place until all the atomic or molecular orbitals are singly occupied.

### **Postulates of Molecular Orbital Theory**

The postulates of Molecular Orbital Theory are:

- The total number of molecular orbitals formed is equal to the total number of atomic orbital offered by atomic species.
- The electrons in the molecular orbital are filled in the increasing order of **orbital energy** (from orbital having lower energy to orbital having higher energy).
- Orbital with lower energy followed by higher orbital energy is the pattern of electron alignment.
- Molecular Orbital Theory describes three types of orbital based on the pattern of electron bonding. These are- Bonding molecular orbital, Non-bonding molecular orbital, Anti-bonding molecular orbital.
- Each atom combines to form a molecular orbital and the electrons are found in various atomic orbital and bonded to different nuclei.
- Most effective combinations of atomic orbitals occur when the combining orbitals have the same energies.
- Electrons are located anywhere within the molecule.

### **Formation of Molecular Orbitals of Molecular Orbital Theory**

According to wave mechanics, the atomic orbitals can be expressed by **wave functions** ( $\psi$ 's). The wave functions also represent the amplitude of the electron waves. These can be obtained from the **Schrodinger wave equation**. However, since the Schrodinger wave equation cannot be solved for any system containing more than one electron, it is difficult to obtain molecular orbitals which are one-electron wave functions for molecules from the solution of the Schrodinger wave equation. To overcome this problem, the Linear Combination of Atomic Orbitals (LCAO) has been adopted.



### Linear Combination of Atomic Orbitals (LCAO) of Molecular Orbital Theory

The conditions that are needed to be satisfied for the linear combination of atomic orbitals are given below:

1. **Same Energy of combining orbitals**– The combining atomic orbitals must have the same or approximately the same energy. This means that the 2p orbital of an atom can combine with another 2p orbital of another atom but 1s and 2p cannot combine as they have energy differences.
2. **Same symmetry about the molecular axis**– The combining atoms should have the same symmetry around the molecular axis for proper combination. For e.g. all the sub-orbitals of 2p have the same energy but still, the 2p<sub>z</sub> orbital of an atom can only combine with a 2p<sub>z</sub> orbital of another atom. It cannot combine with 2p<sub>x</sub> and 2p<sub>y</sub> orbital because they have a different axis of symmetry.
3. **Proper overlapping between the atomic orbitals**– The two atomic orbitals will combine to form a molecular orbital only if the overlap is proper. The greater the extent of overlap of orbitals, the greater will be the nuclear density between the nuclei of the two atoms.

### Types of Molecular Orbital of Molecular Orbital Theory

According to the Molecular Orbital Theory, there are three types of Molecular Orbitals. These Molecular Orbitals are as follows:

1. Bonding Molecular Orbital
2. Anti-bonding molecular orbital
3. Non-bonding molecular orbital

#### 1. Bonding molecular orbital

The molecular orbital which is formed by the addition of overlapping of atomic orbital is called Bonding Molecular Orbital. The addition of wave function indicates the type of molecular orbital formed is Bonding molecular orbital. The orbital energy of the resultant orbital is less than the parent orbital showing the least relative energy. The increased attraction of nuclei between both the sharing electrons is the ultimate reason for the least relative energy of the resultant molecular orbital.

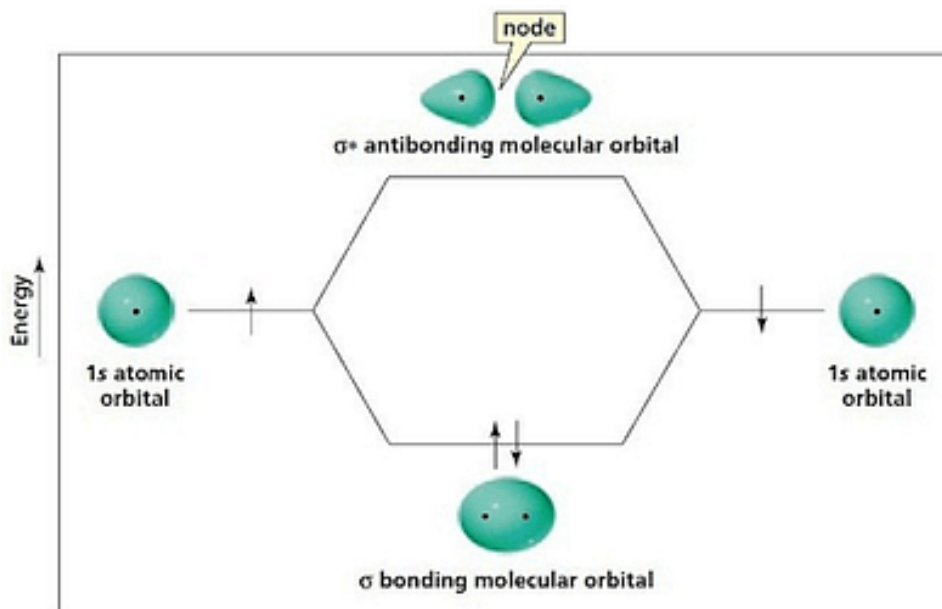

### Characteristics of bonding molecular orbital

The electrons in the bonding molecular orbital are due to the attraction between two atoms and as the result of attraction, the less energy of bonding molecular orbital is achieved. The additive effect of atomic orbital is represented by  $\sigma$ ,  $\pi$ ,  $\delta$ .

### 2. Anti-bonding molecular orbital

The molecular orbital which is formed by the subtraction of overlapping of atomic orbital is called Bonding Molecular Orbital. When subtraction of wave function occurs, it results in the Anti-bonding molecular orbital. The orbital energy of the resultant orbital is greater than the parent orbit. The relative energy is also great in Anti-bonding molecular orbital. The repulsion of nuclei between the sharing electrons is the reason for the greater relative energy.

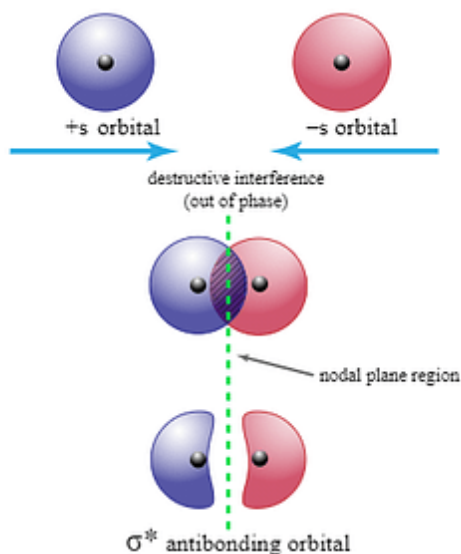

### Characteristics of Anti-bonding molecular orbital

The electrons in the Anti-bonding molecular orbital are due to the repulsion between two atoms. The probability of finding the electron is high in this type of molecular orbital contrast to the former type. The repulsive effect of an atom is represented by  $\pi^*$ ,  $\sigma^*$ ,  $\delta^*$ .

### 3. Non- Bonding molecular orbital

Lack of symmetry between the compatibility of two atomic orbitals will result in the nonbonding molecular orbital. There is no force of attraction and repulsion exists to form wave function between the atoms

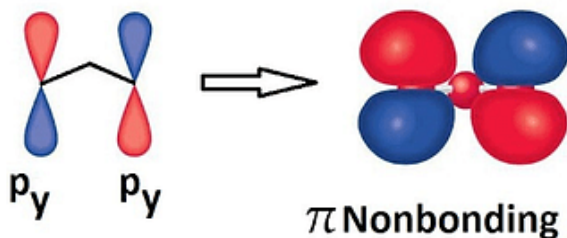

### Characteristics of Nonbonding molecular orbital

The zero-force of attraction and repulsion to form a wave function is the unique feature of the non-bonding molecular orbital. Hence, the orbital energy remains static and shows no difference between the parent orbital and the resultant orbital. The molecular orbitals formed



STUDY MATERIAL FOR B.SC CHEMISTRY  
INORGANIC CHEMISTRY - I  
SEMESTER - I, ACADEMIC YEAR 2022-23



have no positive or negative interactions with each other. These types of orbitals do not affect the bond between the two atoms.

**Example:**

**Oxygen molecule (O<sub>2</sub>):**

Oxygen molecule belongs to the family of diatomic molecules, which consists of two oxygen atoms, bonded to each other by a covalent bond. The electronic configuration of the Oxygen molecule is given as,

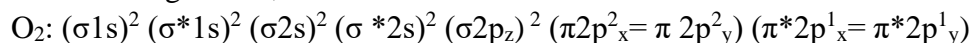

Bond order = (number of electrons in bonding MOT – number of electrons in antibonding MOT)/2

$$\text{Bond order} = (10-6)/2$$

$$\text{Bond order} = 2.$$

Due to the presence of one unpaired electron, O<sub>2</sub> molecule should be paramagnetic.

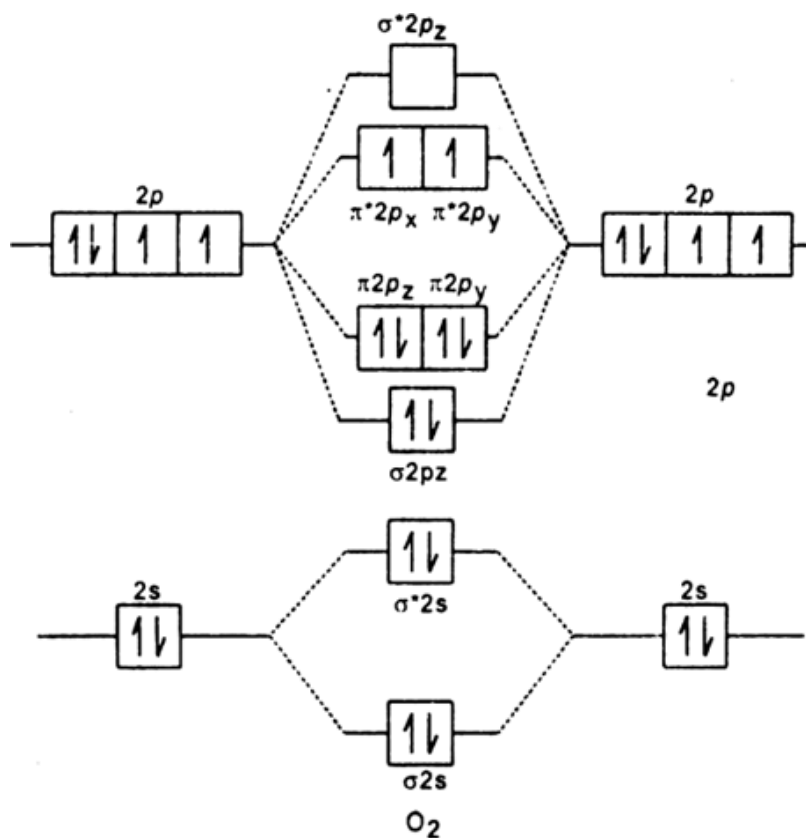



**STUDY MATERIAL FOR B.SC CHEMISTRY  
INORGANIC CHEMISTRY - I  
SEMESTER - I, ACADEMIC YEAR 2022-23**

---



**Comparison of VB and MO Theories**

Both the MO and VB theories are used to help determine the structure of a molecule. Unlike the VB theory, which is largely based off of valence electrons, the MO theory describes structure more in depth by taking into consideration, for example, the overlap and energies of the bonding and antibonding electrons residing in a particular molecular orbital. While MO theory is more involved and difficult, it results in a more complete picture of the structure of a chosen molecule. Despite various shortcomings, complete disregard of one theory and not the other would hinder our ability to describe the bonding in molecules.



**Unit IV**  
**Chemistry Of S And P Block Elements**

**4.1. Inert Pair Effect**

The Inert Pair Effect is often considered to be a minor effect on the properties of an element. But this effect is of profound importance not only on the element but also on the trends of the periodic table. The inert-pair effect occurs mainly in elements that come after the transition elements in the periodic table. It is the tendency of the outermost s-orbital electrons to not participate in chemical reactions.

The inert-pair effect is the phenomenon of non-participation of valence shell filled s-orbital electrons in the chemical reactions of the element or the inability of the electrons in the valence shell s-orbital to ionize.

**Explanation:**

- Inert pair effect can be defined as the reluctance of the outermost shell s- electrons to participate in bonding.
- It is most commonly observed for group 4 and group 5 elements.
- The lower oxidation states of the elements of this group are formed due to the inert pair effect.
- Example: For Sn, there are two oxidation states +2 and +4. Out of these, Sn<sup>2+</sup> is formed due to the inert pair effect, where the valence shell s- electrons remain paired instead of participating in bond formation.

**Diagonal Relationship**

The Modern periodic table is based on the law- "*The chemical properties of elements are a periodic function of their atomic number.*" We have studied the trends along with the group and across the period. The pairs of diagonally adjacent elements in the second and third periodic table are called Diagonal Relationship of the Elements

The diagonal relationship exists between certain elements in the periodic table. These elements are placed diagonally adjacent in the second and third row of the periodic table, among the first twenty elements. The diagonal elements usually show similarities in their properties, which is exhibited on moving from left to right and down the group in the periodic table. It is prominent among the lighter members.



### Diagonal Relationship Between Lithium and Magnesium

	Group 1	Group 2
2 <sup>nd</sup> period	Li	Be
3 <sup>rd</sup> period	Na	Mg

Some of the similarities between Lithium and Magnesium are as follows:

1. Both Li and Mg have almost the same electronegativities.
2. Both Li and Mg have covalent character.
3. They are harder and lighter than other elements in their groups.
4. The hydroxides LiOH and Mg(OH)<sub>2</sub> are weak bases and decompose on heating.  
$$2\text{LiOH} \rightarrow \text{Li}_2\text{O} + \text{H}_2\text{O}$$
$$\text{Mg(OH)}_2 \rightarrow \text{MgO} + \text{H}_2\text{O}$$
5. Chlorides LiCl and MgCl<sub>2</sub> are deliquescent and crystallize from an aqueous hydrate. Also, these chlorides are soluble in ethanol.
6. The hydroxide, carbonate, phosphates and fluorides of both Li and Mg are sparingly soluble in water.

### Diagonal Relationship Between Beryllium and Aluminium

	Group 2	Group 13
2 <sup>nd</sup> period	Be	B
3 <sup>rd</sup> period	Mg	Al

Some of the similarities between Beryllium and Aluminium are as follows:

1. Both elements are metals and tend to form covalent bonds.



STUDY MATERIAL FOR B.SC CHEMISTRY  
INORGANIC CHEMISTRY - I  
SEMESTER - I, ACADEMIC YEAR 2022-23



- Both elements form compounds that have a low melting point and are soluble in the organic solvent.
- The oxides and hydroxides of both elements are amphoteric in nature.
- Both beryllium and aluminium react very slowly with dilute hydrochloric acid to liberate hydrogen gas.
- Both  $\text{BeCl}_2$  and  $\text{AlCl}_3$  act as a catalyst in Friedel -Crafts reaction.
- Both react with the base  $\text{NaOH}$  to liberate hydrogen gas forming beryllates and aluminates.

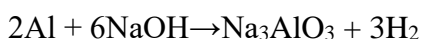
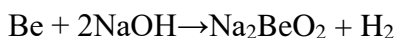

#### 4.2. Allotropes of Carbon

The phenomenon by which an element can exist in more than one physical state is called allotropy. The allotropes of carbon can be categorized into two:

- Amorphous Carbon Allotropes
- Crystalline Carbon Allotropes

##### Allotropes of Carbon

- Diamond:** It is extremely hard, transparent crystal, with the carbon atoms arranged in a tetrahedral lattice. This allotrope of carbon is a poor electrical conductor and an excellent thermal conductor.
- Lonsdaleite:** These are also called hexagonal diamond.
- Graphene:** It is the basic structural element of other allotropes, nanotubes, charcoal, and fullerenes.
- Q-carbon:** These carbon allotropes are ferromagnetic, tough, and brilliant crystal structure that is harder and brighter than diamonds.
- Graphite:** It is a soft, black, flaky solid, a moderate electrical conductor. The C atoms are bonded in flat hexagonal lattices (graphene), which are then layered in sheets.
- Linear acetylenic carbon (**Carbyne**)
- Amorphous carbon
- Fullerenes**, including Buckminsterfullerene, also known as “buckyballs”, such as  $\text{C}_{60}$ .
- Carbon nanotubes:** Allotropes of carbon with a cylindrical nanostructure.

Let us now take a look into the more widely known allotropes of carbon



### 4.3 Graphite

It is also a pure form of carbon. This allotrope of carbon is composed of flat two-dimensional layers of carbon atoms which are arranged hexagonally. It is a soft, black and slippery solid. This property of graphite persists because it cleaves easily between the layers. In each layer, each C atom is linked to three C atoms via a C-C covalent bond. Each carbon here is  $sp^2$  hybridized. The fourth bond is formed as a pi bond. Since, the  $\pi$ -electrons are delocalized, they are mobile and can conduct electricity.

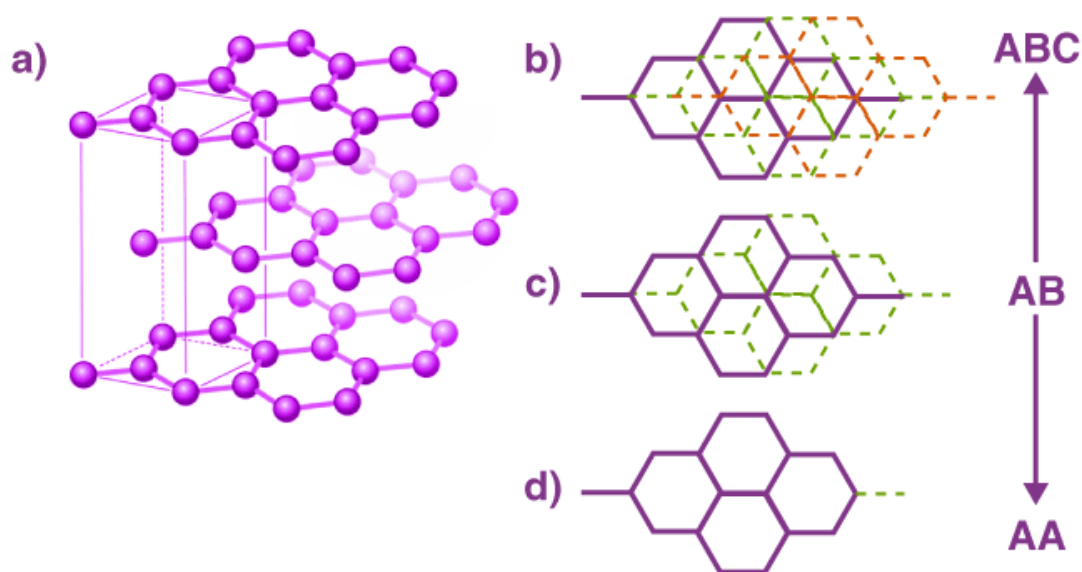

**Graphite is of two forms:  $\alpha$  and  $\beta$ .**

In  $\alpha$  form, the layers are arranged in the sequence of ABAB with the third layer exactly above the first layer. In the  $\beta$  form, the layers are arranged as ABCABC.

#### Properties of Graphite:

- Since the layers are stacked over each other, this carbon allotrope can act as a lubricant.
- It also has metallic lustre which helps in the conduction of electricity. It is a very good conductor of both heat and electricity
- One of the most important properties of graphite is that it is used as a dry lubricant for machines at high temperature where we cannot use oil.



- Graphite is used to make crucibles which have the property that they are inert to dilute acids as well as to alkalis.

**Note:** In comparison to diamond, Graphite is thermodynamically more stable.

### Structure of Carbon Allotrope (Graphite):

Graphite has a unique honeycomb layered structure. Each layer is composed of planar hexagonal rings of carbon atoms in which carbon-carbon bond length within the layer is 141.5 picometers. Out of four carbon atoms three forms sigma bonds whereas the fourth carbon forms pi-bond. The layers in graphite are held together by Vander Waal forces.

### Diamond

It is the purest crystalline allotrope of carbon. It has a number of carbons, linked together tetrahedrally. Each tetrahedral unit consists of carbon bonded to four carbon atoms which are in turn bonded to other carbons. This gives rise to an allotrope of carbon having a three-dimensional arrangement of C-atoms. Each carbon is  $sp^3$  hybridized and forms covalent bonds with four other carbon atoms at the corners of the tetrahedral structure. It is hard because breaking a diamond crystal involves rupturing many strong covalent bonds. Breaking covalent bonds is no easy task. This property makes this carbon allotrope the hardest element on earth.

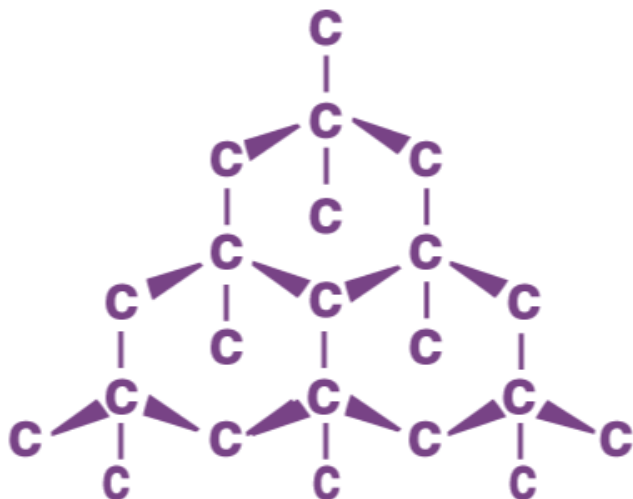



### Physical Properties of Diamond

- It is extremely hard
- It has a very high melting point
- It has a high relative density
- It is transparent to X-rays
- It has a high value of the refractive index
- It is a bad conductor of electricity
- It is a good conductor of heat
- It is insoluble in all solvents

### Buckminster fullerene

Buckminsterfullerene (C<sub>60</sub>) is also one of the allotropes of carbon. The structure of fullerene is like in a cage shape due to which it looks like a football.

### Fullerenes

They are spheroidal molecules having the composition, C<sub>2n</sub>, where  $n \geq 30$ . These carbon allotropes can be prepared by evaporating graphite with a laser.

Unlike diamond, fullerenes dissolve in organic solvents. The fullerene C<sub>60</sub> is called 'Buckminster Fullerene'. The carbon atoms are sp<sup>2</sup> hybridized. **Note:** There are 12 five-membered rings and 20 six-membered rings in C<sub>60</sub>.

### 4.4. Allotropes of sulphur

We can find sulphur in a number of structures in the same physical state. However, the most important crystalline structures are rhombic or octahedral ( $\alpha$  – sulphur), and monoclinic sulfur ( $\beta$  – sulphur). We find the shape of rhombic sulphur at a temperature beneath 96°C. On the other hand, monoclinic sulphur occurs at a temperature over 96°C. This temperature of 96°C is the transitional temperature between the two crystalline structures. There is another allotrope of sulphur, polymeric sulfur (S<sub>8</sub>). It is an eight-part ring particle. This is insoluble in organic media, synthetic and natural rubber. It also does not dissolve in carbon disulphide.

Let us now look at the properties of the two main allotropes of sulphur: rhombic and monoclinic sulphur.



### 1) Rhombic Sulphur

- We find them as yellow and translucent crystals.
- Rhombic Sulphur has a melting point of  $114^{\circ}\text{C}$ .
- The density of rhombic Sulphur is  $2.08\text{ g/cm}^3$
- It is stable at temperatures below  $96^{\circ}\text{C}$ .

### 2) Monoclinic Sulphur

- These are transparent and amber crystals.
- They have a melting point of  $119^{\circ}\text{C}$ .
- The density of monoclinic sulphur is  $1.98\text{ gcm}^3$
- It is unstable at temperatures below  $96^{\circ}\text{C}$  and changes into rhombic form.
- We must remember that at a temperature of  $96^{\circ}\text{C}$  or above, rhombic sulphur changes to kaleidoscopic or prismatic sulphur. At  $96^{\circ}\text{C}$  or beneath, kaleidoscopic or prismatic sulphur changes to rhombic sulphur.
- These allotropes that alter their configuration from one form to another by a change in the temperature are Enantiotropic Allotropes.

### 3) Colloidal Sulphur

- We can produce this sulphur by passing hydrogen sulphide through a saturated and cooled solution of sulphur dioxide in water. Another method is by including a solution of alcohol and sulphur in the water.
- It acts as a solvent in carbon disulfide.
- We utilise it as a part of medicines.

### 4) Milk of Sulphur

- We can produce this by the action of weak hydrochloric acid on ammonium sulphide. In a similar fashion, this milk of sulphur forms by the boiling of sulphur with calcium hydroxide (aqueous solution). We filter this mixture and add weak hydrochloric acid to get the milk of sulphur.
- This compound is non-crystalline and white in colour.
- It is soluble in carbon disulphide.
- At the point when we heat it, it changes to the conventional yellow colour of sulphur that we use as a part of medicines.



## 4.5. Allotropes of Phosphorus

### White Phosphorus

- It is white in colour and exists as a waxy solid.
- It has a translucent appearance, is poisonous, and is insoluble in water.
- It is soluble in  $\text{CS}_2$  and exhibits chemiluminescence (glows in dark).
- It is more reactive than other carbon allotropes. When burned, it emits white  $\text{P}_4\text{O}_{10}$  fumes.
- It has a tetrahedral structure.

### Red Phosphorus

- It's made from white phosphorus. To produce red phosphorus, white phosphorus is heated at 573K in an inert atmosphere for several days.
- Red phosphorus is odourless, colourless, non-poisonous, and lustrous.
- It is not soluble in water or  $\text{CS}_2$ .
- It has a lower reactivity than white phosphorus.
- It has chains made up of  $\text{P}_4$  tetrahedra that are linked together.

### Black Phosphorus

- There are two types of black phosphorus: alpha black phosphorus and beta black phosphorus.
- The crystal structure of alpha black phosphorus is opaque monoclinic or rhombohedral. It is made by heating red phosphorus in a sealed tube at 803K.
- Beta black phosphorus has a low reactivity. It is made by heating white phosphorus under high pressure at 473K.

## 4.6. Silicates

Fusing alkali oxides with  $\text{SiO}_2$  gives silicates. They contain discrete tetrahedral units. Silicon is  $\text{sp}^3$  hybridized. These allotropes of carbon are classified based on their structures.



1. **Orthosilicates:** They contain discrete  $\text{SiO}_4$  units. For example, Willemite ( $\text{ZrSiO}_4$ ).



2. **Pyrosilicate:** Two units are linked together via an oxygen atom. The simplest ion of this type is  $\text{Si}_2\text{O}_7$ . For example, Thortveite ( $\text{Sc}_2[\text{Si}_2\text{O}_7]$ ).

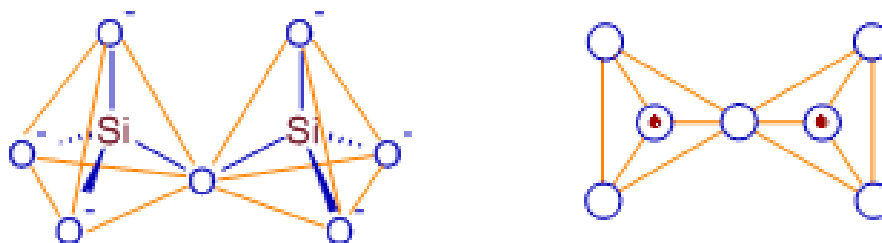

3. **Cyclic Silicates:** The units share two oxygen atoms. Only two ions are known as of now,  $\text{Si}_3\text{O}_9$  and  $\text{Si}_6\text{O}_{18}$ . For example, Beryl –  $\text{Be}_3\text{Al}_2\text{Si}_6\text{O}_{18}$ .

### Cyclic Silicates

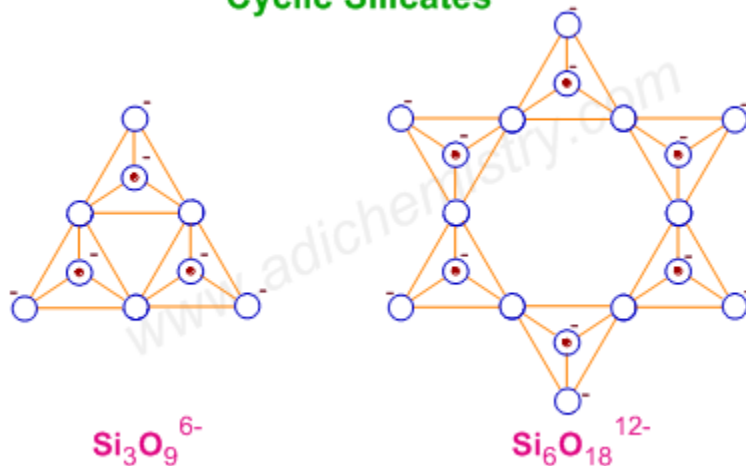

4. **Chain Silicates:** The linking of the units linearly results in the formation of chain silicates. They are of two types:

- **Metasilicates:** Each tetrahedral unit shares two oxygen atoms to form a single chain carbon allotrope. For example, Spodumene  $\text{NaAl}(\text{SiO}_3)_2$ .



- **Amphiboles:** When two linear chains are linked together, it results in amphiboles carbon allotrope. The parallel chains are held by sharing the oxygen atoms. For example, Asbestos:  $\text{CaMg}_3\text{O}(\text{Si}_4\text{O}_{11})$ .

### Chain Silicates

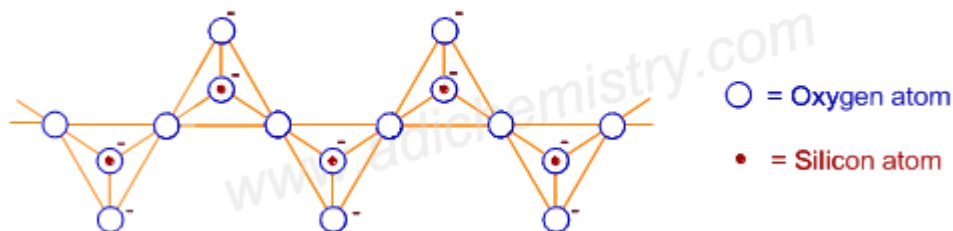

### Amphibole silicates

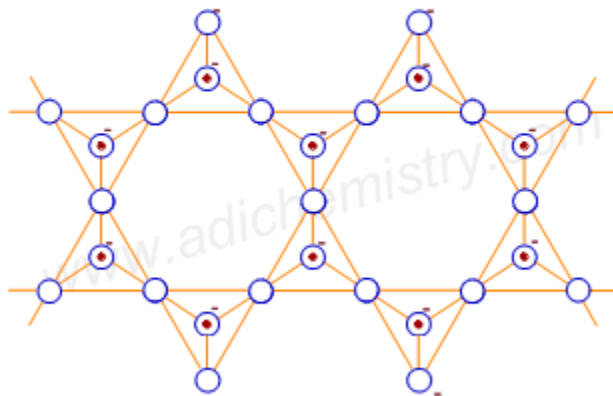

4. **Two-dimensional silicates:** Sharing of three oxygen atoms results in the formation of a two-dimensional silicate. For example, mica.

### Sheet (phyllo) Silicates

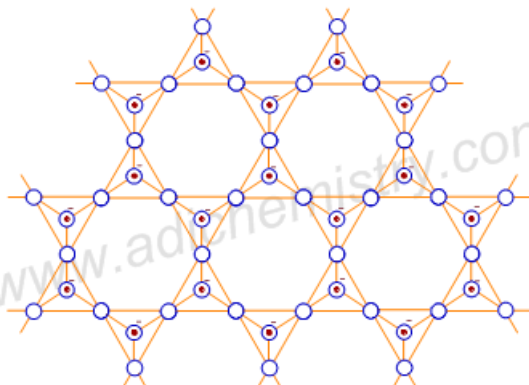



**STUDY MATERIAL FOR B.SC CHEMISTRY  
INORGANIC CHEMISTRY - I  
SEMESTER - I, ACADEMIC YEAR 2022-23**



5. **Three-dimensional silicate:** When all the oxygen atoms are shared, it results in a three-dimensional network. For example, Zeolites.

#### 4.7. Zeolites

- Zeolites are microporous, aluminosilicate minerals commonly used as commercial adsorbents and catalysts.
- Zeolites have small openings of fixed size in them. This allows small molecules to pass through them easily. However, larger molecules cannot pass through them. This is why they are sometimes called molecular sieves.
- **Formation:**
  - Zeolites occur naturally and can also be produced industrially on a large scale.
  - Natural zeolites form where volcanic rocks and ash layers react with alkaline groundwater.
  - However, naturally occurring zeolites are rarely pure and are contaminated to varying degrees by other minerals.
  - For this reason, naturally occurring zeolites are excluded from important commercial applications.
- **Properties of Zeolites:**
  - Zeolites are very stable solids that resist a variety of environmental conditions. The melting point of zeolite is very high (over 1000°C), and they don't burn.
  - They also resist high pressures.
  - They don't get dissolved in water or other inorganic solvents and don't oxidize in the air.
  - Since zeolites are not reactive and are obtained from naturally occurring minerals, they do not have any harmful environmental effects.
- **Uses of Zeolites:**
  - Zeolites are widely used as ion-exchange beds in domestic and commercial water purification, softening, and other applications.
  - They have the potential of providing precise and specific separation of gases. This includes the removal of H<sub>2</sub>O, CO<sub>2</sub>, and SO<sub>2</sub> from low-grade natural gas streams.
  - Zeolites are also marketed as dietary supplements to treat cancer, diarrhoea, autism, herpes, and hangover. It is also used to balance pH and remove heavy metals in the body.



#### 4.8. Glass

Glass is a non-crystalline amorphous solid that is often transparent and has widespread practical, technological, and decorative usage in, for example, window panes, tableware, and optoelectronics. Firstly the glass was manufactured in Egypt. Ordinary glass is manufactured by the composition of various substances like silica, bleaching powder, oxides of alkaline metals, calcium oxide (lime) etc. Firstly the glass was manufactured in Egypt. Basically glass is the homogenous mixture of the silicates of various alkaline metals of non-crystalline and transparent or less transparent substances. Ordinary glass is manufactured by the composition of various substances like silica, bleaching powder, oxides of alkaline metals, calcium oxide (lime) etc. These constituents of the glass are transformed into fine micro powder and after fusing these are melted into the furnaces at moderate temperature and ordinary glass is prepared by a suitable cooling mechanism of the molten or liquid glass. Thus ordinary glass is a non-crystalline substance of ultra cooled liquid glass.

#### Types of Glass

**Water glass:** It is manufactured from the compound of sodium silicate ( $\text{Na}_2\text{SiO}_3$ ) by heating sodium carbonate and silica. It is soluble in water.

**Photo chromatic glass:** This is a special type of glass which turns black in sharp shining light thus such glasses are used as light protector and eyes reliever and thereby utilised in making eye lenses and goggles. The main reason of being black of such glasses is the presence of silver iodide.

**Pyrex glass:** It is also called borosilicate glass. It has some specific characteristics of chemical durability and more thermal inmalleable resistance power.

**Lead crystal glass:** This is a special type of glass which is used in making various ornamental items by the appropriate decorative, cutting and designing. Infact on cutting such glasses the optical phenomenon of total internal reflection takes place very sharply and thus a pleasurable dazzling light is produced.

**Soda glass:** It is also called soft glass which is brittle and the cheapest and most commonly existing glasses. This can be broken very conveniently and by the alternation of temperature some cracks appear in such glasses.



**STUDY MATERIAL FOR B.SC CHEMISTRY**  
**INORGANIC CHEMISTRY - I**  
**SEMESTER - I, ACADEMIC YEAR 2022-23**



**Xena Glass:** It is the best form of glass and from it chemical containers and equipments for the scientific purposes are manufactured. This glass is basically composed from zinc and barium borosilicate which produces the soft and good quality of glass.

**Flint Glass:** It is manufactured from sodium, potassium and lead silicates which are used in making idol objects of cultural importance, costly glass equipments or devices. Such glasses are also used in making electric bulbs, lenses of telescopes, microscopes, camera and prisms, etc.

**Crown glass:** Usually this is a soda-lime-silica glass and it is frequently used in making lenses of eye glasses.

**Crookes glass:** In this glass mainly cerium oxide ( $\text{CeO}_2$ ) is present which sharply absorbs the ultraviolet rays from the sunlight so utilised in making lenses of eye glasses.

**Quartz glass:** This is also called silica glass because it is obtained by melting silica and ultraviolet rays emerge out through it. Thus it is used in making bulb of ultraviolet lamp, in making container of chemical reagents, laboratories equipments etc.

**Glasses, composition and uses**

Glasses	Composition	Uses
<b>Soda Glasses</b>	Sodium Carbonate, Calcium Carbonate and Silica	In making tube light, bottles, equipments of laboratory, daily useable domestic utensils
<b>Flint Glass</b>	Potassium Carbonate	In making of electric bulbs, lenses of camera and telescope etc.
<b>Crookes Glass</b>	Cerium Oxide and Silica	In making lenses of goggles.
<b>Potash Glass</b>	Potassium Carbonate, Calcium Carbonate and Silica	In making glass container and laboratory equipments, glass utensils which are heated up to very high temperature.
<b>Pyrex Glass</b>	Barium Silicate and Sodium Silicate	In making laboratory equipments and pharmaceutical containers or vessels.
<b>Crown Glass</b>	Potassium Oxide, Barium Oxide and Silica	In making lenses of eyes glass.



**STUDY MATERIAL FOR B.SC CHEMISTRY  
INORGANIC CHEMISTRY - I  
SEMESTER - I, ACADEMIC YEAR 2022-23**



<b>Lead crystal glass</b>	Potassium Carbonate, lead Oxide and Silica	In making costly glass containers or vessels etc.
---------------------------	--	---

### How glasses get coloured?

During the preparation of glasses its various components or constituents in the molten or fused state are sometimes altered (replaced) or more appropriately some extraneous substances like metallic oxides are accessed or added, then glasses become coloured. Also various accessible substances produce different colours in the glasses. For example; On accessing ferric oxide in ordinary fused glass a brown coloured glass produces. Similarly the substances like chromic oxide, manganese dioxide, cobalt oxide etc. on mixing (accessing) in fused glass, green, red and blue coloured glasses are produced. Generally for the fascinating coloured glasses small quantity of metallic compounds are accessed in the molten or fused state with their constituent's component.

<b>Substance used for colouring the glass</b>	<b>Colour of glasses</b>
Cobalt Oxide	Deep Blue
Sodium Chromate or Ferrous Oxide	Green
Selenium Oxide	Orange red
Ferric Salt or Sodium Uranet	Fluorescent Yellow
Gold Chloride or Purple of Cassias	Ruby red
Cuprous Oxide, Cadmium Sulphide	Glitter red
Cupric salt	Peacock Blue
Potassium dichromate	Green and green yellow
Manganese dioxide	Blue to light orange
Cuprous salt	Red
Cadmium sulphide	Yellow like lemon
Carbon	Brownish black



#### 4.9. Portland Cement

Chemical composition of Portland Cement:

- Tricalcium Silicate (50%)
- Dicalcium Silicate (25%)
- Tricalcium Aluminate (10%)
- Tetracalcium Aluminoferrite (10%)
- Gypsum (5%)

##### Function : Tricalcium Silicate

- Hardens rapidly and largely responsible for initial set & early strength
- The increase in percentage of this compound will cause the early strength of Portland Cement to be higher.
- A bigger percentage of this compound will produce higher heat of hydration and accounts for faster gain in strength.

##### Function : Dicalcium Silicate

- Hardens slowly
- Its effects on strength increase occurs at ages beyond one week.
- Responsible for long term strength

##### Function : Tricalcium Aluminate

- Contributes to strength development in the first few days because it is the first compound to hydrate.
- It turns out higher heat of hydration and contributes to faster gain in strength.
- But it results in poor sulfate resistance and increases the volumetric shrinkage upon drying.
- Cements with low Tricalcium Aluminate contents usually generate less heat, develop higher strengths and show greater resistance to sulfate attacks.
- It has high heat generation and reacts with soils and water containing moderate to high sulfate concentrations so it's least desirable.

##### Function : Tetracalcium Aluminoferrite

- Assist in the manufacture of Portland Cement by allowing lower clinking temperature.
- Also act as a filler



**STUDY MATERIAL FOR B.SC CHEMISTRY  
INORGANIC CHEMISTRY - I  
SEMESTER - I, ACADEMIC YEAR 2022-23**



- Contributes very little strength of concrete eventhough it hydrates very rapidly.
- Also responsible for grey colour of Ordinary Portland Cement

### **Manufacturing Of Portland Cement**

The 3 primary constituents of the raw materials used in the manufacture of Portland Cement are:

- a) Lime
- b) Silica
- c) Alumina

Lime is derived from limestone or chalk

Silica & Alumina from clay, shale or bauxite.

There are 2 chief aspects of the manufacturing process:

#### **First**

To produce a finely divided mixture of raw materials – chalk / limestone and clay / shale

#### **Second**

To heat this mixture to produce chemical composition

There 2 main process that can be used in manufacturing of Portland Cement that is

- i) wet process
- ii) dry process

#### **Wet Process**

- Raw materials are homogenized by crushing, grinding and blending so that approximately 80% of the raw material pass a No.200 sieve.
- The mix will be turned into form of slurry by adding 30 – 40% of water.
- It is then heated to about 2750°F (1510°C) in horizontal revolving kilns (76-153m length and 3.6-4.8m in diameter).
- Natural gas, petroluem or coal are used for burning. High fuel requirement may make it uneconomical compared to dry process.

#### **Dry Process**

- Raw materials are homogenized by crushing, grinding and blending so that approximately 80% of the raw material pass a No.200 sieve.
- Mixture is fed into kiln & burned in a dry state



**STUDY MATERIAL FOR B.SC CHEMISTRY  
INORGANIC CHEMISTRY - I  
SEMESTER - I, ACADEMIC YEAR 2022-23**



- This process provides considerable savings in fuel consumption and water usage but the process is dustier compared to wet process that is more efficient than grinding.

### **Dry Proces & Wet Process**

- In the kiln, water from the raw material is driven off and limestone is decomposed into lime and Carbon Dioxide.

limestone  $\longrightarrow$  lime + Carbon Dioxide

- In the burning zone, portion of the kiln, silica and alumina from the clay undergo a solid state chemical reaction with lime to produce calcium aluminate.

silica & alumina + lime  $\longrightarrow$  calcium aluminate

- The rotation and shape of kiln allow the blend to flow down the kiln, submitting it to gradually increasing temperature.
- As the material moves through hotter regions in the kiln, calcium silicates are formed
- These products, that are black or greenish black in color are in the form of small pellets, called cement clinkers
- Cement clinkers are hard, irregular and ball shaped particles about 18mm in diameter.
- The cement clinkers are cooled to about 150°F (51°C) and stored in clinker silos.
- When needed, clinker are mixed with 2-5% gypsum to retard the setting time of cement when it is mixed with water.
- Then, it is grounded to a fine powder and then the cement is stored in storage bins or cement silos or bagged.
- Cement bags should be stored on pallets in a dry place.



## Unit V

### Principles of Qualitative and Quantitative analysis

#### 5.1. Dry Test

##### 1. Physical Examination

In physical examination of compound colour, smell, density etc, are observed.

Physical Examination

Observation	Inference
(A) Colour of Compound	
(i) Blue, Whose aqueous solution is also blue.	Hydrated salts of $\text{Cu}^{2+}$ (except $\text{CO}_3^{2-}$ and $\text{Cl}^-$ )
(ii) Blue, Whose aqueous solution is pink	Anhydrous salts of cobalt
(iii) Colourless substance	Transition metals absent (except some salts of $\text{Mn}^{2+}$ )
(iv) Green, Whose aqueous solution is also green and on dilution colour is not changed too much	Salts of $\text{Ni}^{2+}$ , $\text{Cr}^{3+}$
(v) yellow-green, aqueous solution is light green or almost colourless	Salts of $\text{Fe}^{2+}$
(vi) Yellow-brown, aqueous solution is yellow	Salts of $\text{Fe}^{3+}$
(vii) Violet-pink, aqueous solution is pink	Salts of cobalt
(viii) Black, Substance.	$\text{CuO}$ , $\text{NiO}$ , $\text{SnO}$ , $\text{FeS}$ , $\text{CuS}$ , $\text{HgS}$ , $\text{PbS}$ , $\text{NiS}$ , $\text{CoS}$ , $\text{CuBr}_2$ , $\text{Ag}_2\text{S}$ , $\text{Cu}_2\text{S}$ , $\text{MnO}_2$ , $\text{Fe}_3\text{O}_4$ , $\text{FeO}$ , $\text{Co}_3\text{O}_4$ , $\text{Ni}_2\text{O}_3$ etc.
(ix) Brown Substance	$\text{CdO}$ , $\text{PbO}_2$ , $\text{SnS}$ ,



STUDY MATERIAL FOR B.SC CHEMISTRY  
INORGANIC CHEMISTRY - I  
SEMESTER - I, ACADEMIC YEAR 2022-23



	$\text{Bi}_2\text{S}_3$ , $\text{MnCO}_3$ (pale brown), $\text{CuCrO}_4$ , $\text{SnS}$ .
(x) Yellow substance	$\text{Bi}_2\text{O}_3$ , $\text{CdS}$ , $\text{SnS}_2$ , $\text{As}_2\text{S}_3$ , $\text{PbI}_2$ , Chromates, $\text{As}_2\text{S}_5$ , $\text{AgI}$ etc.
(xi) Red substance	$\text{Cu}_2\text{O}$ , $\text{HgO}$ , $\text{Pb}_3\text{O}_4$ , $\text{HgI}_2$ etc.
(xii) Orange substance	$\text{Cr}_2\text{O}_7^{2-}$ salts, $\text{Sb}_2\text{S}_3$ etc.
(xiii) Green substance	$\text{K}_2\text{MnO}_4$ , Carbonate or Chloride of $\text{Cu}^{2+}$
(xiv) Light pink	Hydrated $\text{Mn}^{2+}$ salts
(xv) Purple.	$\text{KMnO}_4$ & other permanganates, some $\text{Cr}^{3+}$ salts.

**(B) Odour of Compound**

(i) Ammonical smell	$\text{NH}_4^+$ salts
(ii) Vinegar like smell	Acetates
(iii) Like smell from rotten eggs.	$\text{S}^{2-}$ salts.

**(C) Density**

(i) Mixture or salt is heavy	Hg and Pb salts
(ii) Mixture or salt is light.	Salts of Zn, Al, Bi, Ca, Ba, Sr, Mg etc. (Chiefly carbonates)



**STUDY MATERIAL FOR B.SC CHEMISTRY  
INORGANIC CHEMISTRY - I  
SEMESTER - I, ACADEMIC YEAR 2022-23**



**(D) Exposure of Air**

- |   |  |
|---|--|
| (i) Colourless, deliquescent substance which is changed to paste. | SbCl <sub>3</sub> , ZnCl <sub>2</sub> , CaCl <sub>2</sub> , Zn(NO <sub>3</sub> ) <sub>2</sub>                      |
| (ii) Coloured, deliquescent substance which is changed to paste.  | Cu(NO <sub>3</sub> ) <sub>2</sub> , FeCl <sub>3</sub> , Fe(NO <sub>3</sub> ) <sub>2</sub> , MnCl <sub>2</sub> etc. |
| (iii) Colour of substance is changed from white to yellow         | Cd salts   |
| (iv) Colour of substance is changed from white to black           | Pb or Bi salts.  |

**2. Effect of Heating**

In a clean, dry test tube, substance is first heated gently and then strongly.

**Effect of heating**

**Observation**

**Inference**

- |                     |  |
|---------------------|--|
| 1. Substance melts  | Salts of alkali metals chloride of Hg, Pb, Ag etc. having water of crystallization   |
| 2. Substance cracks | KI, NaCl, Pb(NO <sub>3</sub> ) <sub>2</sub> , Ba(NO <sub>3</sub> ) <sub>2</sub> etc. |
| 3. Substance swells | Alum, borates, phosphates etc  |

**3. Colour of residue obtained after heating**

<b>Hot</b>	<b>Cold</b>	
(i) Orange yellow	White	Zn salts
(ii) Brown	Yellow	salts of Pb, Bi or Sn
(iii) Red or black	Brown	Cd salts



**STUDY MATERIAL FOR B.SC CHEMISTRY  
INORGANIC CHEMISTRY - I  
SEMESTER - I, ACADEMIC YEAR 2022-23**



(iv) white	Blue	Cupric salts ( $\text{CuSO}_4$ )
(v) Blue	Blue-red	$\text{COCl}_2$
(vi) Green	Dark red	$\text{CoBr}_2$
(vii) Violet	Dark red	$\text{CoI}_2$
(viii) Yellow	Green	Ni salts
(ix) Green	Violet	Cr salts
(x) Black		
(non-fusible)	Black	$\text{CuO}$ , $\text{MnO}_2$ , $\text{NiO}$
(xi) Dark red brown		
(non-fusible)	Light brown	$\text{Fe}_2\text{O}_3$
(xii) Dark orange-red	Light orange-red	$\text{HgO}$

**4. Substance sublimes on heating and colour of sublimate is**

(i) White	$\text{HgCl}_2$ , $\text{Hg}_2\text{Cl}_2$ , $\text{As}_2\text{O}_3$ , $\text{AlCl}_3$ , $\text{NH}_4^+$ , halides, $\text{Sb}_2\text{O}_3$ etc.
(ii) Greyish black	$\text{HgS}$
(iii) Yellow	S, $\text{As}_2\text{S}_3$ , $\text{HgI}_2$ etc
(iv) Yellow-blue or violet vapour	$\text{I}_2$
(v) Grey (having garlic odour)	As

**5. Observation of gases evolved**

(A) Colourless and odourless gas:

(i) Which supports the combustion of burning match stick Nitrates of alkali metals



**STUDY MATERIAL FOR B.SC CHEMISTRY**  
**INORGANIC CHEMISTRY - I**  
**SEMESTER - I, ACADEMIC YEAR 2022-23**



(O<sub>2</sub>).

(ii) Which turns the lime water milky (CO<sub>2</sub>).

CO<sub>3</sub><sup>2-</sup> or C<sub>2</sub>O<sub>4</sub><sup>2-</sup> salts

(B) Colourless, odorous gas:

(i) Smell of ammonia (NH<sub>3</sub>).

Ammonium salts.

(ii) Smell of burning sulphur (SO<sub>2</sub>).

Sulphite salts or FeSO<sub>4</sub>

(iii) Smell of rotten eggs (H<sub>2</sub>S)

Sulphide salts.

(iv) Pungent smelling gas, which gives white fumes with NH<sub>4</sub>OH.

Hydrated chloride salt

(C) Coloured odorous gases:

(i) Brown gas which turns starch-iodide paper blue (NO<sub>2</sub>)

Nitrates or nitrites of heavy metals

(ii) Red-brown gas which turns starch-paper yellow.

Bromide salts

(iii) Violet gas which turns starch paper blue

Iodide salts

(iv) Yellow-green gas which decolorizes the litmus paper.

Chloride salts

## 6. Smell of Compound

Smell of a compound also gives idea about the salt.

S. No.	Smell	Inference
1.	Bitter almond type smell	Cyanides
2.	Ammonical smell	Ammonium salts
3.	Chlorine like smell	Hypochlorites
4.	Vinegar like smell	Acetates



## 5.2.Flame Test

A flame test is a qualitative analysis used by the chemist to identify the metal and metalloid ion in the sample. Not all metal ions emit colour when heated in the gas burner. A flame test is the simplest way of identifying the presence of group 1 metal ions in the compound. For other metals, there are plenty of reliable techniques, but a flame test will give a better hint on where to look.

There are some safety techniques to perform the flame test in the laboratory.

- Use chemical splash/impact goggles
- Perform the flame test under the direction or supervision of chemistry teachers.

When the sample is heated, metal ions gain energy and shift from a lower energy level to a higher energy level. Ions are not stable at a high energy level, and they return to the ground with energy-release. The energy is released in the form of light and it varies from one metal ion to another. Thus, each metal ion gives a characteristic change of colour when it is heated.

Practical details to carry out the flame test

### Platinum or nickel-chromium alloy (nichrome) wire.

- Cleaning the wire is achieved by dipping it in the concentrated solution of HCl (hydrochloric acid) and burning it in the hot bunsen burner flame until the wire shows no colour in the flame.
- The clean wire is either dipped into the powder or in the ionic metal salt solution, then the wire is heated in the bunsen burner flame.
- Observe and record the flaming colour

Flame colours for common ions

Ions	Flame colour
Lithium	Red
Sodium	strong, persistent orange (yellow)
Potassium	lilac (pink)
Calcium	orange-red
Rubidium	red (red-violet)



**STUDY MATERIAL FOR B.SC CHEMISTRY  
INORGANIC CHEMISTRY - I  
SEMESTER - I, ACADEMIC YEAR 2022-23**

---



Barium	pale green
Lead	grey-white
Copper	blue-green (often with white flashes)
Strontium	red
Barium	pale green
Caesium	blue/violet
Boron	Bright green
Arsenic	Blue
Iron	Gold
Magnesium	Bright white
Manganese (II)	Yellow-green
Molybdenum	Yellow-green
Phosphorous	Pale blue-green
Antimony	Pale green
Strontium	Crimson
Selenium	Bright blue
Thallium	Bright green
Tellurium	Pale green
Zinc	Blue-green to pale green
Bismuth	Azure
Cadmium	Brick red
Cerium	Yellow
Cobalt	Silver-white
Chromium	Silver-white
Mercury	Red
Molybdenum	Yellowish green



**STUDY MATERIAL FOR B.SC CHEMISTRY**  
**INORGANIC CHEMISTRY - I**  
**SEMESTER - I, ACADEMIC YEAR 2022-23**



Tin	Blue-white
Zirconium	Mild red

### Identification Of Acid Radicals (Anions)

The identification of the acid radicals is first done on the basis of preliminary tests. Dry heating test is one of the preliminary tests performed earlier which may give some important information about the acid radical present. The other preliminary tests are based upon the fact that:

1.  $\text{CO}_3^{2-}$ ,  $\text{S}^{2-}$ ,  $\text{SO}_3^{2-}$  and  $\text{NO}_2^-$  react with dil.  $\text{H}_2\text{SO}_4$  to give out  $\text{CO}_2$ ,  $\text{H}_2\text{S}$ ,  $\text{SO}_2$  and  $\text{NO}_2$  gas respectively which can be identified by certain tests.
2.  $\text{Cl}^-$ ,  $\text{Br}^-$ ,  $\text{I}^-$ ,  $\text{NO}_3^-$ ,  $\text{C}_2\text{O}_4^{2-}$  and  $\text{CH}_3\text{COO}^-$  react with cone.  $\text{H}_2\text{SO}_4$  but not with dil.  $\text{H}_2\text{SO}_4$  to produce characteristic gases.
3.  $\text{SO}_4^{2-}$  and  $\text{PO}_4^{3-}$  react neither with dil.  $\text{H}_2\text{SO}_4$  nor with cone.  $\text{H}_2\text{SO}_4$ . These are therefore, identified by individual tests.

### 5.3. Test for Acid radicals

Thus, the acid radicals may be identified by performing the following tests in the order given below :

- (i) **Dil.  $\text{H}_2\text{SO}_4$  test.** Treat a pinch of the salt with dil.  $\text{H}_2\text{SO}_4$  and identify the gas evolved.
- (ii) **Cone.  $\text{H}_2\text{SO}_4$  test.** If no action takes place with dil.  $\text{H}_2\text{SO}_4$ , warm a pinch of the salt with cone.  $\text{H}_2\text{SO}_4$  and identify the gas evolved.
- (iii) **Independent Group.** ( $\text{SO}_4^{2-}$  and  $\text{PO}_4^{3-}$ ). If the salt does not react with dil.  $\text{H}_2\text{SO}_4$  as well as with cone.  $\text{H}_2\text{SO}_4$ , test for  $\text{SO}_4^{2-}$  and  $\text{PO}_4^{3-}$  by performing their individual tests. Let us now discuss these tests in detail one by one.

### Dilute Sulphuric Acid Test

Take a small quantity of the salt in a test-tube and add 1-2 ml of dilute sulphuric acid. Observe whether some gas is evolved or not. If some gas is evolved, identify the gas and draw inferences from Table



### Dilute Sulphuric Acid Test

Observations	Inference	
	Gas Evolved	Possible Radical
1. Colourless, odourless gas with brisk effervescence, turns lime water milky.	CO <sub>2</sub>	CO <sub>3</sub> <sup>2-</sup>
2. Colourless gas, smell like that of rotten eggs, turns 'lead acetate paper black.	H <sub>2</sub> S	S <sup>2-</sup>
3. Colourless gas, smell like that of burning sulphur, turns acidified potassium dichromate paper green.	SO <sub>2</sub>	SO <sub>3</sub> <sup>2-</sup>
4. Reddish brown gas, pungent smell, turns ferrous sulphate solution black.	NO <sub>2</sub>	NO <sub>2</sub> <sup>-</sup>
5. No gas is evolved.	—	CO <sub>3</sub> <sup>2-</sup> , S <sup>2-</sup> , SO <sub>3</sub> <sup>2-</sup> , NO <sub>2</sub> <sup>-</sup> absent

### Chemical Reactions Involved in Dil. H<sub>2</sub>SO<sub>4</sub> Test

Dilute H<sub>2</sub>SO<sub>4</sub> (or dilute HCl) decomposes carbonates, sulphides sulphites and nitrites in cold to and liberates different gases. These gases on identification indicate the nature of the acid radical present in the salt.

**1. Carbonates.** On treating the solid carbonate, CO<sub>2</sub> is given off in the cold with brisk effervescence.

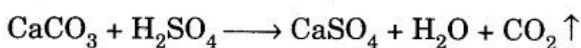

**2. Sulphides.** Sulphides when treated with dil. H<sub>2</sub>SO<sub>4</sub> give H<sub>2</sub>S gas.

**3. Sulphites.** Sulphites when treated with dil. H<sub>2</sub>SO<sub>4</sub> give SO<sub>2</sub> gas.

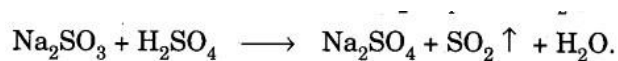



**STUDY MATERIAL FOR B.SC CHEMISTRY  
INORGANIC CHEMISTRY - I  
SEMESTER - I, ACADEMIC YEAR 2022-23**



4. **Nitrites.** On treating the solid nitrite with dil.  $\text{H}_2\text{SO}_4$ , nitric oxide (NO) gas is evolved which readily gives dense brown fumes of  $\text{NO}_2$  with oxygen of the air.

Qualitative Analysis Identification Of Acid Radicals (Anions)

July 19, 2016 by [Sastry CBSE](#)

**Identification Of Acid Radicals (Anions)**

The identification of the acid radicals is first done on the basis of preliminary tests. Dry heating test is one of the preliminary tests performed earlier which may give some important information about the acid radical present. The other preliminary tests are based upon the fact that:

1.  $\text{CO}_3^{2-}$ ,  $\text{S}^{2-}$ ,  $\text{SO}_3^{2-}$  and  $\text{NO}_2^-$  react with dil.  $\text{H}_2\text{SO}_4$  to give out  $\text{CO}_2$ ,  $\text{H}_2\text{S}$ ,  $\text{SO}_2$  and  $\text{NO}_2$  gas respectively which can be identified by certain tests.
2.  $\text{Cl}^-$ ,  $\text{Br}^-$ ,  $\text{I}^-$ ,  $\text{NO}_3^-$ ,  $\text{C}_2\text{O}_4^{2-}$  and  $\text{CH}_3\text{COO}^-$  react with cone.  $\text{H}_2\text{SO}_4$  but not with dil.  $\text{H}_2\text{SO}_4$  to produce characteristic gases.
3.  $\text{SO}_4^{2-}$  and  $\text{PO}_4^{3-}$  react neither with dil.  $\text{H}_2\text{SO}_4$  nor with cone.  $\text{H}_2\text{SO}_4$ . These are therefore, identified by individual tests.

Thus, the acid radicals may be identified by performing the following tests in the order given below :

- (i) **Dil.  $\text{H}_2\text{SO}_4$  test.** Treat a pinch of the salt with dil.  $\text{H}_2\text{SO}_4$  and identify the gas evolved.
- (ii) **Cone.  $\text{H}_2\text{SO}_4$  test.** If no action takes place with dil.  $\text{H}_2\text{SO}_4$ , warm a pinch of the salt with cone.  $\text{H}_2\text{SO}_4$  and identify the gas evolved.
- (iii) **Independent Group.** ( $\text{SO}_4^{2-}$  and  $\text{PO}_4^{3-}$ ). If the salt does not react with dil.  $\text{H}_2\text{SO}_4$  as well as with cone.  $\text{H}_2\text{SO}_4$ , test for  $\text{SO}_4^{2-}$  and  $\text{PO}_4^{3-}$  by performing their individual tests. Let us now discuss these tests in detail one by one.



STUDY MATERIAL FOR B.SC CHEMISTRY  
INORGANIC CHEMISTRY - I  
SEMESTER - I, ACADEMIC YEAR 2022-23



### Dilute Sulphuric Acid Test

Take a small quantity of the salt in a test-tube and add 1-2 ml of dilute sulphuric acid. Observe whether some gas is evolved or not. If some gas is evolved, identify the gas and draw inferences from Table 9.7.

Table 9.7. Dilute Sulphuric Acid Test

Observations	Inference	
	Gas Evolved	Possible Radical
1. Colourless, odourless gas with brisk effervescence, turns lime water milky.	CO <sub>2</sub>	CO <sub>3</sub> <sup>2-</sup>
2. Colourless gas, smell like that of rotten eggs, turns 'lead acetate paper black.	H <sub>2</sub> S	S <sup>2-</sup>
3. Colourless gas, smell like that of burning sulphur, turns acidified potassium dichromate paper green.	SO <sub>2</sub>	SO <sub>3</sub> <sup>2-</sup>
4. Reddish brown gas, pungent smell, turns ferrous sulphate solution black.	NO <sub>2</sub>	NO <sub>2</sub> <sup>-</sup>
5. No gas is evolved.	—	CO <sub>3</sub> <sup>2-</sup> , S <sup>2-</sup> , SO <sub>3</sub> <sup>2-</sup> , NO <sub>2</sub> <sup>-</sup> absent

#### Note:

1. Do not treat the salt with a large quantity of dilute acid.
2. Do not heat the salt with dilute acid.

#### Chemical Reactions Involved in Dil. H<sub>2</sub>SO<sub>4</sub> Test

Dilute H<sub>2</sub>SO<sub>4</sub> (or dilute HCl) decomposes carbonates, sulphides sulphites and nitrites in cold to and liberates different gases. These gases on identification indicate the nature of the acid radical present in the salt.

**1. Carbonates.** On treating the solid carbonate, CO<sub>2</sub> is given off in the cold with brisk

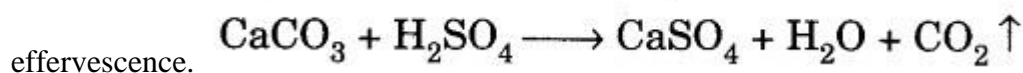



**STUDY MATERIAL FOR B.SC CHEMISTRY  
INORGANIC CHEMISTRY - I  
SEMESTER - I, ACADEMIC YEAR 2022-23**



**2. Sulphides.** Sulphides when treated with dil.  $\text{H}_2\text{SO}_4$  give  $\text{H}_2\text{S}$  gas.

**3. Sulphites.** Sulphites when treated with dil.  $\text{H}_2\text{SO}_4$  give  $\text{SO}_2$  gas.

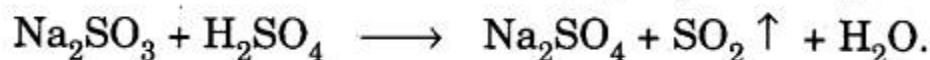

**4. Nitrites.** On treating the solid nitrite with dil.  $\text{H}_2\text{SO}_4$ , nitric oxide (NO) gas is evolved which readily gives dense brown fumes of  $\text{NO}_2$  with oxygen of the air.

### Potassium Permanganate Test

To a pinch of salt in test tube add about 2 ml of dilute sulphuric acid. Boil off any gas evolved, add little more of dilute acid and then potassium permanganate solution dropwise. Note the changes as given in Table 9.8. This test helps in detection of  $\text{Cl}^-$ ,  $\text{Br}^-$ ,  $\text{I}^-$ ,  $\text{C}_2\text{O}_4^{2-}$ , and  $\text{Fe}^{2+}$  radicals.

**Table 9.8. Potassium Permanganate Test**

Observations	Inference
1. Potassium permanganate decolourised without the evolution of any gas.	Presence of $\text{Fe}^{2+}$ salts.
2. Potassium permanganate decolourised : (a) In cold (i) With the evolution of chlorine. (ii) With the evolution of bromine. (iii) With the evolution of iodine. (b) On warming (i) With the evolution of carbon dioxide	$\text{Cl}^-$ $\text{Br}^-$ $\text{I}^-$  $\text{C}_2\text{O}_4^{2-}$
3. $\text{KMnO}_4$ not decolourised.	Absence of $\text{Cl}^-$ , $\text{Br}^-$ , $\text{I}^-$ , $\text{C}_2\text{O}_4^{2-}$ and $\text{Fe}^{2+}$



**STUDY MATERIAL FOR B.SC CHEMISTRY  
INORGANIC CHEMISTRY - I  
SEMESTER - I, ACADEMIC YEAR 2022-23**



**Chemical reaction involved in permanganate reaction**



1. *Ferrous salts* :

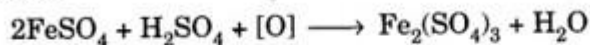

2. *Chlorides* :



3. *Bromides* :



4. *Iodides* :



**Concentrated Sulphuric Acid Test**

This test is performed by treating small quantity of the salt with cone. sulphuric acid (2-3 ml) in a test tube. Identify the gas evolved in cold and then on heating.

**Cone. Sulphuric Acid Test**

Observations	Inference	
	Gas Evolved	Possible Radical
1. Colourless gas with pungent smell. The gas gives white fumes with aqueous ammonia (NH <sub>4</sub> OH) and white ppt. with AgNO <sub>3</sub> solution.	HCl	Cl <sup>-</sup>
2. Reddish brown vapours with pungent smell, turns starch paper yellow. It does not turn FeSO <sub>4</sub> solution black.	Br <sub>2</sub>	Br <sup>-</sup>
3. Deep violet vapours with pungent smell, turns starch paper blue. A sublimate is formed on the sides of the tube.	I <sub>2</sub> vapours	I <sup>-</sup>
4. Reddish brown gas with pungent smell, turns FeSO <sub>4</sub> solution black.	NO <sub>2</sub>	NO <sub>2</sub> <sup>-</sup>



**STUDY MATERIAL FOR B.SC CHEMISTRY**  
**INORGANIC CHEMISTRY - I**  
**SEMESTER - I, ACADEMIC YEAR 2022-23**



5. Colourless gas which turns lime water milky and a gas which burns with blue flame.	CO <sub>2</sub> and CO	C <sub>2</sub> O <sub>4</sub> <sup>2-</sup>
6. No gas/vapours evolved.	—	Cl <sup>-</sup> , Br <sup>-</sup> , I <sup>-</sup> , CH <sub>3</sub> COO <sup>-</sup> , C <sub>2</sub> O <sub>4</sub> <sup>2-</sup> absent

**Note**

1. If some gas is evolved with dilute sulphuric acid, then there is no need for performing cone, sulphuric acid test.
2. Do not boil the salt with cone, sulphuric acid. On boiling, the acid may decompose to give SO<sub>2</sub> gas.
3. Nitrates give vapours of nitric acid (colourless) when heated with cone, sulphuric acid. When a paper pellet or copper chips is added, dense brown fumes evolve. Paper pellet acts as a reducing agent and reduces nitric acid to NO<sub>2</sub> (Reddish brown gas).

**Chemical Reactions Involved in cone. H<sub>2</sub>SO<sub>4</sub> Test**

**3. Iodides**



**4. Nitrates**

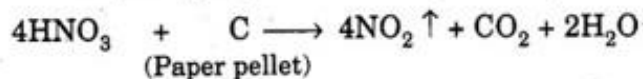

**5. Acetates**

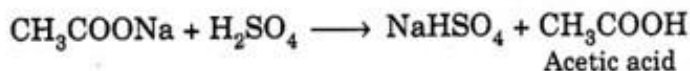

**6. Oxalates :**

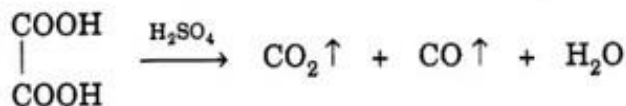
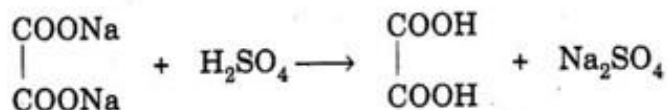



### Tests For Independent Radicals ( $\text{SO}_4^{2-}$ and $\text{PO}_4^{3-}$ )

As already discussed these radicals are not detected by dilute or concentrated  $\text{H}_2\text{SO}_4$ . They are tested individually.

#### 1. SULPHATE ( $\text{SO}_4^{2-}$ )

Boil a small amount of salt with dilute HCl in a test tube. Filter the contents, and to the filtrate add few drops of  $\text{BaCl}_2$  solution. A **white precipitate**, insoluble in cone. HCl, indicates presence of sulphate.

#### 2. PHOSPHATE ( $\text{PO}_4^{3-}$ )

Add cone.  $\text{HNO}_3$  to the salt in a test tube. Boil the contents and add excess of ammonium molybdate solution. A **yellow precipitate** indicates presence of phosphate.

### 5.6. Classification of Basic Radicals

Basic radical are divided into six analytical groups, and each group has its reagent which is called group reagent, The group reagent reacts with the salt solution to give an insoluble salts precipitated, Identification of the basic radicals depends upon the properties of the precipitate, The basic radicals of the salt to be identified are in the form of solutions.

Classification depends on differing in solubility of the salts of these [metals](#) in [water](#), for example, metal chloride of the first analytical group which are chloride of silver (I), mercury (I), lead (II) are sparingly soluble in [water](#), so, they can be precipitated as chloride on adding the group reagent which is dil hydrochloric acid.

#### Second analytical group

Cations of this group are precipitated in the form of sulphides in acidic medium, by dissolving the salt in water and adding dilute Hydrochloric acid to it to make solution acidic then passing hydrogen sulphide gas to it,  $\text{Cu}^{2+}$  is one from this group.

**Test for copper (II) cation  $\text{Cu}^{2+}$ :** Copper (II) salt solution + group reagent ( $\text{HCl} + \text{H}_2\text{S}$ ), black ppt. from copper (II) sulphide is formed soluble in hot nitric acid.

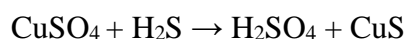



### Third analytical group

They are precipitated as hydroxides using ammonium hydroxide if they are not mixed with other cations, Cations such as  $\text{Al}^{3+}$ ,  $\text{Fe}^{2+}$ ,  $\text{Fe}^{3+}$ .

#### Aluminium $\text{Al}^{3+}$

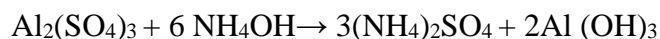

White gelatinous ppt. of Aluminium hydroxide soluble in dil Acids and in Caustic soda. Salt solution + sodium hydroxide solution  $\rightarrow$  white gelatinous ppt. of Aluminum hydroxide soluble in excess sodium hydroxide forming sodium meta aluminate.

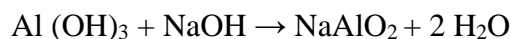
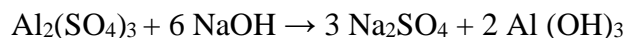

#### Iron (II) $\text{Fe}^{2+}$

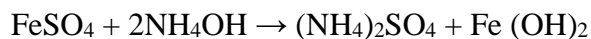

White ppt. turns white green when it is exposed to air and soluble in acids.

Salt solution + sodium hydroxide solution  $\rightarrow$  white green ppt. of iron (II) hydroxide is formed.

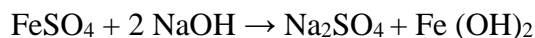

#### Iron (III) $\text{Fe}^{3+}$

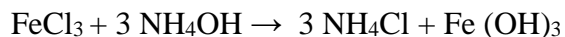

Reddish brown gelatinous ppt. soluble in acids. Salt solution + sodium hydroxide solution  $\rightarrow$  Reddish brown ppt. of iron (III) hydroxide is formed.

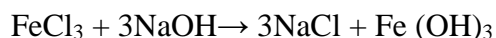

### Fifth analytical group

Cations of this group are precipitated as carbonates by addition of ammonium carbonate.

Salt solution + ammonium carbonate solution (group reagent)



### Calcium Ca<sup>2+</sup>

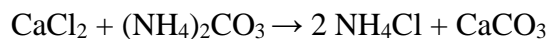

a white ppt. of calcium carbonate soluble in dil HCl and also in water containing CO<sub>2</sub>.



Salt solution + dil sulphuric acid → A white ppt. of calcium sulphate is formed.

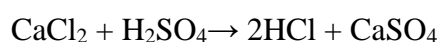

Flame test: Volatile calcium cation gives bunsen a brick red colour.

### 5.7. Solubility Product, K<sub>sp</sub>

The solubility product constant is the equilibrium constant for the dissolution of a solid substance into an aqueous solution. It is denoted by the symbol K<sub>sp</sub>. The solubility product is a kind of equilibrium constant and its value depends on temperature. K<sub>sp</sub> usually increases with an increase in temperature due to increased solubility.

Solubility is defined as a *property of a substance called solute to get dissolved in a solvent in order to form a solution*. The solubility of ionic compounds (which disassociate to form cations and anions) in water varies to a great deal. Some compounds are highly soluble and may even absorb moisture from the atmosphere whereas others are highly insoluble.

### Significance of Solubility Product

Solubility depends on a number of parameters amongst which lattice enthalpy of salt and solvation enthalpy of ions in the solution are of most importance.

- When a salt is dissolved in a solvent the strong forces of attraction of solute (lattice enthalpy of its ions) must be overcome by the interactions between ions and the solvent.
- The solvation enthalpy of ions is always negative which means that energy is released during this process.
- The nature of the solvent determines the amount of energy released during solvation that is solvation enthalpy.
- Non-polar solvents have a small value of solvation enthalpy, meaning that this energy is not sufficient to overcome the lattice enthalpy.



**STUDY MATERIAL FOR B.SC CHEMISTRY  
INORGANIC CHEMISTRY - I  
SEMESTER - I, ACADEMIC YEAR 2022-23**



- So the salts are not dissolved in non-polar solvents. Hence, for salt to be dissolved in a solvent, its solvation enthalpy should be greater than its lattice enthalpy.
- Solubility depends on temperature and it is different for every salt.

Salts are classified on the basis of their solubility in the following table.

Category I	Soluble	Solubility > 0.1M
Category II	Slightly soluble	0.01M < Solubility < 0.1M
Category III	Sparingly soluble	Solubility < 0.1M

### **Solubility Product Constant**

Suppose barium sulphate along with its saturated aqueous solution is taken. The following equation represents the equilibrium set up between the undissolved solids and ions:

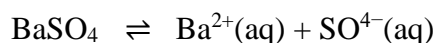

The equilibrium constant in the above case is:

$$K = \frac{[\text{Ba}^{2+}][\text{SO}_4^{2-}]}{[\text{BaSO}_4]}$$

In case of pure solid substances the concentration remains constant, and so we can say:

$$K_{sp} = K[\text{BaSO}_4] = [\text{Ba}^{2+}][\text{SO}_4^{2-}]$$

Here  $K_{sp}$  is known as the solubility product constant. This further tells us that solid barium sulphate when in equilibrium with its saturated solution, the product of concentrations of ions of both barium and sulphate is equal to the solubility product constant.

### **5.8. Common Ion Effect**

The statement of the common ion effect can be written as follows – in a solution wherein there are several species associating with each other via a chemical equilibrium process, an increase in the concentration of one of the ions dissociated in the solution by the addition of



**STUDY MATERIAL FOR B.SC CHEMISTRY  
INORGANIC CHEMISTRY - I  
SEMESTER - I, ACADEMIC YEAR 2022-23**



another species containing the same ion will lead to an increase in the degree of association of ions.

An example of the common ion effect can be observed when gaseous hydrogen chloride is passed through a sodium chloride solution, leading to the precipitation of the NaCl due to the excess of chloride ions in the solution (brought on by the dissociation of HCl). This effect cannot be observed in the compounds of transition metals. This is because the d-block elements have a tendency to form complex ions. This can be observed in the compound cuprous chloride, which is insoluble in water. This compound can be dissolved in water by the addition of chloride ions leading to the formation of the  $\text{CuCl}_2^-$  complex ion, which is soluble in water.

### **Effect on Solubility**

The way in which the solubility of a salt in a solution is affected by the addition of a common ion is discussed in this subsection.

- The common ion effect can be used to obtain drinking water from aquifers (underground layer of water mixed with permeable rocks or other unconsolidated materials) containing chalk or limestone. Sodium carbonate (chemical formula  $\text{Na}_2\text{CO}_3$ ) is added to the water in order to decrease the hardness of the water.
- In the treatment of water, the common ion effect is used to precipitate out the calcium carbonate (which is sparingly soluble) from the water via the addition of sodium carbonate, which is highly soluble.
- A finely divided calcium carbonate precipitate of a very pure composition is obtained from this addition of sodium carbonate. The  $\text{CaCO}_3$  precipitate is, therefore, a valuable by-product which can be used in the process of manufacturing toothpaste.
- Since soaps are the sodium salts of carboxylic acids containing a long aliphatic chain (fatty acids), the common ion effect can be observed in the salting-out process which is used in the manufacturing of soaps. The soaps are precipitated out by adding sodium chloride to the soap solution in order to reduce its solubility.

However, it can be noted that water containing a respectable amount of  $\text{Na}^+$  ions, such as seawater and brackish water, can hinder the action of soaps by reducing their solubility and therefore their effectiveness.



## pH and the Common-Ion Effect

When the conjugate ion of a buffer solution (solution containing a base and its conjugate acid, or acid and its conjugate base) is added to it, the pH of the buffer solution changes due to the common ion effect.

- An example of such an effect can be observed when acetic acid and sodium acetate are both dissolved in a given solution, generating acetate ions. However, sodium acetate completely dissociates but the acetic acid only partly ionizes. This is because acetic acid is a weak acid whereas sodium acetate is a strong electrolyte.
- As per Le Chatelier's principle, the new acetate ions put forth by sodium acetate facilitate the suppression of the ionization of acetic acid, thereby shifting the equilibrium to the left. Since the dissociation of acetic acid is reduced, the pH of the solution is increased.
- Therefore, the common ion solution containing acetic acid and sodium acetate will have an increased pH and will, therefore, be less acidic when compared to an acetic acid solution.

Thus, the common ion effect, its effect on the solubility of a salt in a solution, and its effect on the pH of a solution are discussed in this article.

## 5.9. Intergroup Separation of Cations

### A. Precipitation of Group I ( $\text{Ag}^+$ , $\text{Hg}_2^{+2}$ , and $\text{Pb}^{+2}$ ).

1. Place a 1 mL portion of the Group I-V known sample in a small test tube. The known sample contains cations from all five groups. Add dilute HCl dropwise with stirring until the solution is acid to litmus. Add one drop of excess HCl. Formation of a white precipitate indicates the presence of one or more Group I cations. The reactions are shown below.

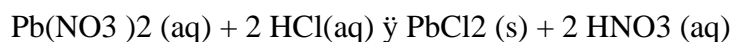
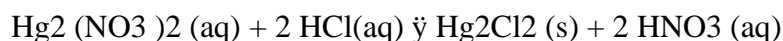
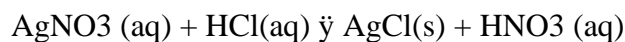

2. If the reaction mixture is warm after the addition of HCl, run cold water over the outside of the test tube before separating out the precipitate. Centrifuge to separate the precipitate from the



**STUDY MATERIAL FOR B.SC CHEMISTRY  
INORGANIC CHEMISTRY - I  
SEMESTER - I, ACADEMIC YEAR 2022-23**



supernatant liquid. CAUTION: The centrifuge must be balanced. Place a test tube containing an equal volume of liquid opposite your test tube. An unbalanced centrifuge is dangerous because it may wobble and fall from the bench top. Transfer the supernatant liquid to another test tube. Keep the supernatant liquid! The supernatant liquid contains cations in Groups II-V. Wash the precipitate with 1 mL of distilled water, centrifuge, and combine the washings with the supernatant liquid. Discard the precipitate.

**B. Analysis of Group II (Pb<sup>+2</sup>, Hg<sup>+2</sup>, Bi<sup>+3</sup>, and Cu<sup>+2</sup>).**

1. To the supernatant liquid from the precipitation of Group I add dilute NH<sub>3</sub> dropwise with stirring until the solution is just basic to litmus. Make the solution just acidic by dropwise addition of dilute HCl (1 drop may be sufficient), then add 1 drop excess. Any precipitates which appear on addition of aqueous NH<sub>3</sub> will be converted to sulfides in the next step.

2. Add 10 drops of thioacetamide (CH<sub>3</sub>C(S)NH<sub>2</sub>) and place the test tube in a 100 mL beaker of boiling water for 5 minutes. CAUTION: Be sure to carry out this heating process under the student hood. Highly toxic H<sub>2</sub>S(g) is generated from the hydrolysis of thioacetamide. Add 1 mL of distilled water and an additional 10 drops of thioacetamide and place the test tube in boiling water for an additional 5 minutes. It is essential to complete both stages of the thioacetamide precipitation even though a precipitate may have been obtained after the first stage. The formation of a dark-colored precipitate indicates the presence of one or more Group II cations. The reactions are shown below.

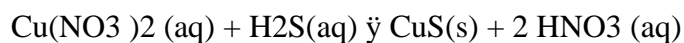
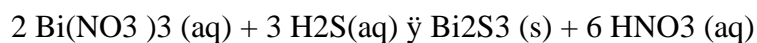
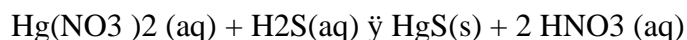
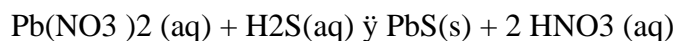

4. Centrifuge the precipitate and transfer the supernatant liquid to another test tube. Keep the supernatant liquid! The supernatant liquid contains cations in Groups III-V. Wash the precipitate with 1 mL of distilled water, centrifuge, and combine the washings with the supernatant liquid. Discard the precipitate. Transfer the liquid to an evaporating dish. Evaporate to a volume of about 1 mL.



**STUDY MATERIAL FOR B.SC CHEMISTRY  
INORGANIC CHEMISTRY - I  
SEMESTER - I, ACADEMIC YEAR 2022-23**



**C. Analysis of Group III (Ni<sup>+2</sup>, Mn<sup>+2</sup>, Fe<sup>+3</sup>, and Al<sup>+3</sup>).**

1. Transfer the supernatant liquid to a small test tube. Add 5 drops NH<sub>4</sub>Cl(aq), 10 drops dilute NH<sub>3</sub>, and 10 drops thioacetamide. Place test tube in a 100 mL beaker of boiling water for 5 minutes. CAUTION: Again and due to the formation of H<sub>2</sub>S(g), carry out this heating process under the student hood. The formation of a precipitate indicates that one or more Group III cations are present. The reactions are shown below.

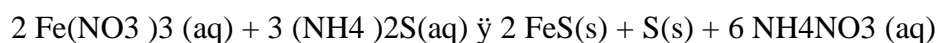
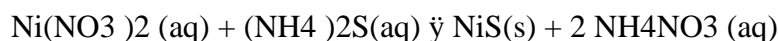

2. Centrifuge the precipitate and transfer the supernatant liquid to another test tube. Keep the supernatant liquid! The supernatant liquid contains cations in Groups IV-V. Wash the precipitate with 1 mL of distilled water, centrifuge, and combine the washings with the supernatant liquid. Discard the precipitate. Acidify the supernatant liquid with HCl and place the test tube in boiling water for 10 minutes to boil off the H<sub>2</sub>S. Centrifuge and discard any precipitate which forms.

**D. Analysis of Group IV (Ca<sup>+2</sup>, Sr<sup>+2</sup>, and Ba<sup>+2</sup>).**

1. To the supernatant liquid from the precipitation of Group III, add 10 drops of NH<sub>4</sub>Cl. Add dilute NH<sub>3</sub> dropwise with stirring until the solution is just basic to litmus. Add 10 drops of (NH<sub>4</sub>)<sub>2</sub>CO<sub>3</sub>. Stir and place the test tube in a beaker of boiling water for 5 minutes. The formation of a white precipitate indicates the presence of Group IV. The reactions are shown below.

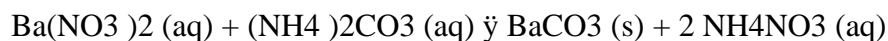
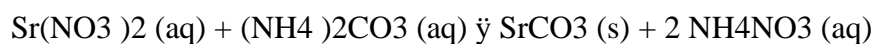
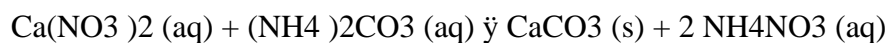

2. At this point the supernatant liquid would contain cations from Group V. This group of cations is often referred to as the soluble cation group, since the cations in this group do not react or precipitate with any of the four group reagents.



**STUDY MATERIAL FOR B.SC CHEMISTRY  
INORGANIC CHEMISTRY - I  
SEMESTER - I, ACADEMIC YEAR 2022-23**

---



**E. Analysis of Unknown (contains cations from Groups I-IV).**

1. To determine which groups are present in your unknown, repeat the precipitation and analysis procedures (outlined in A-D) on your unknown. Not all groups will be present in your unknown. If a group is absent, proceed immediately to the next group analysis. Centrifuging is not necessary unless a precipitate is obtained. If a given group is present, you should obtain about the same amount of precipitate for it as you obtained from the known solution. Small amounts of precipitates in Groups II and III may result from improper separations of previous groups or from the formation of sulfur (resulting from oxidation of  $H_2S$ ). A milky Group I



STUDY MATERIAL FOR B.SC CHEMISTRY  
INORGANIC CHEMISTRY - I  
SEMESTER - I, ACADEMIC YEAR 2022-23



Group	Group reagent	ions	Formula of precipitate
Group 1 (silver group)	cold, dilute-hydrochloric acid	Hg <sub>2</sub> <sup>2+</sup> , Pb <sup>2+</sup> , Ag <sup>+</sup>	Hg <sub>2</sub> Cl <sub>2</sub> , PbCl <sub>2</sub> , AgCl
Group II (Copper and arsenic group)	H <sub>2</sub> S in presence of dilute HCl	Hg <sup>2+</sup> , Pb <sup>2+</sup> , Bi <sup>3+</sup> , Cu <sup>2+</sup> , Cd <sup>2+</sup> , Sn <sup>2+</sup> , Sb <sup>3+</sup> , As <sup>3+</sup>	HgS, PbS, Bi <sub>2</sub> S <sub>3</sub> , CuS, CdS, SnS, Sb <sub>2</sub> S <sub>3</sub> , As <sub>2</sub> S <sub>3</sub>
Group III (Iron group)	Aq. NH <sub>3</sub> in presence of aq. And NH <sub>4</sub> Cl	Al <sup>3+</sup> , Cr <sup>3+</sup> , Fe <sup>3+</sup> , Mn <sup>3+</sup>	Al(OH) <sub>3</sub> , Cr(OH) <sub>3</sub> , Fe(OH) <sub>3</sub> , Mn(OH) <sub>3</sub> ,
Group IV (Zinc Group)	H <sub>2</sub> S in presence of aq. And NH <sub>4</sub> Cl	Ni <sup>2+</sup> , Co <sup>2+</sup> , Mn <sup>2+</sup> , Zn <sup>2+</sup> .	NiS, CoS, MnS, ZnS
Group V (Calcium Group)	(NH <sub>4</sub> ) <sub>2</sub> CO <sub>3</sub> in presence of aq. And NH <sub>4</sub> Cl	Ba <sup>2+</sup> , Ca <sup>2+</sup> , Sr <sup>2+</sup>	BaCO <sub>3</sub> , SrCO <sub>3</sub> , CaCO <sub>3</sub>
Group VI (Alkali Group)	No particular reagent	Mg <sup>2+</sup> , K <sup>+</sup> , Na <sup>+</sup> , NH <sub>4</sub> <sup>+</sup>	Different ppted form